

AD-755 383

**LONG-TERM STORAGE TESTING OF PROPELLANT
TANKAGE**

Howard M. White

Air Force Rocket Propulsion Laboratory
Edwards Air Force Base, California

December 1972

DISTRIBUTED BY:

NTIS

National Technical Information Service
U. S. DEPARTMENT OF COMMERCE
5285 Port Royal Road, Springfield Va. 22151

AFRPL-TR-72-126

AD755383

LONG-TERM STORAGE TESTING OF PROPELLANT TANKAGE

H. M. WHITE, Capt, USAF

TECHNICAL REPORT AFRPL-TR-72-126

DECEMBER 1972

DEC 15 1972
FEB 15 1973

THIS DOCUMENT HAS BEEN APPROVED FOR PUBLIC
RELEASE AND SALE; ITS DISTRIBUTION IS UNLIMITED.

Reproduced by
NATIONAL TECHNICAL
INFORMATION SERVICE
U.S. Department of Commerce
Springfield VA 22151

AIR FORCE ROCKET PROPULSION LABORATORY

DIRECTOR OF SCIENCE AND TECHNOLOGY

AIR FORCE SYSTEMS COMMAND

UNITED STATES AIR FORCE

EDWARDS, CALIFORNIA

98

NOTICES

"When U. S. Government drawings, specifications, or other data are used for any purpose other than a definitely related Government procurement operation, the Government thereby incurs no responsibility nor any obligation whatsoever, and the fact that the Government may have formulated, furnished, or in any way supplied the said drawings, specifications or other data, is not to be regarded by implication or otherwise, or in any manner licensing the holder or any other person or corporation, or conveying any rights or permission to manufacture use, or sell any patented invention that may in any way be related thereto."

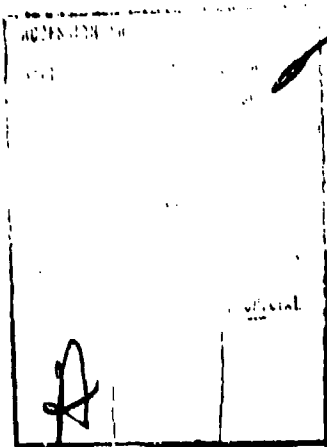

UNCLASSIFIED

Security Classification

DOCUMENT CONTROL DATA - R & D

(Security classification of title, body of abstract and indexing annotation must be entered when the overall report is classified)

1. ORIGINATING ACTIVITY (Corporate author) Air Force Rocket Propulsion Laboratory Edwards, California		10. REPORT SECURITY CLASSIFICATION UNCLASSIFIED	
2. REPORT TITLE Long-Term Storage Testing of Propellant Tankage			
4. DESCRIPTIVE NOTES (Type of report and inclusive dates) Technical (through June 1972)			
3. AUTHOR(S) (First name, middle initial, last name) Howard M. White, Capt, USAF			
5. REPORT DATE December 1972		7a. TOTAL NO. OF PAGES 98	7b. NO. OF REFS 5
6. CONTRACT OR GRANT NO. a. PROJECT NO. 305810RJ		8. ORIGINATOR'S REPORT NUMBER(S) AFRPL-TR-72-126	
10. DISTRIBUTION STATEMENT This document has been approved for public release and sale; its distribution is unlimited.		9. OTHER REPORT NUMB (Any other numbers that may be assigned this report)	
11. SUPPLEMENTARY NOTES Details of illustrations in this document may be better studied on microfiche.		12. SPONSORING MILITARY ACTIVITY Air Force Rocket Propulsion Laboratory Air Force Systems Command, USAF Edwards, California 93523	
13. ABSTRACT <p>The Air Force Rocket Propulsion Laboratory (AFRPL) is performing a program to investigate the performance of storable liquid system components and tankage under severe conditions of relative humidity and temperature. A variety of system components and tankage materials is being evaluated for long-term storability with liquid rocket fuels and oxidizers. Storage conditions are +85°F temperature and 85 percent relative humidity for oxidizer systems, and +65°F to +165°F temperature and uncontrolled humidity for fuel systems. The propellants under test are N₂O₄, ClF₅, N₂H₄, and MHF-5. Tankage materials under test are various alloys of aluminum, steel, and titanium. Tankage is joined by automatic and manual TIG, EB and solid-state bonding techniques.</p> <p>The results of almost four years of testing on a representative number of tankage materials have indicated that leakage of oxidizers can occur as a result of improper weld joint design, inadequate quality control in fabrication and improper acceptance leak testing. Factors which can contribute to the development of oxidizer leakage are high ambient relative humidity (>30 percent) and stress corrosion cracking susceptibility of tank material in combination with propellant and trace quantities of foreign compounds/elements in the propellant. Testing of fuels has revealed no problems with the long term, high temperature (>100°F) storage of hydrazine in a variety of materials.</p>			

DD FORM 1 NOV 68 1473

I-a

UNCLASSIFIED
Security Classification

UNCLASSIFIED
Security Classification

14 KEY WORDS	LINK A		LINK B		LINK C	
	ROLE	WT	ROLE	WT	ROLE	WT
Propellant Storage						
Environmental Effects						
Propellant Leakage						
Corrosion						
Oxidizer Leakage						
Stress Corrosion						
Hydrazine Fuels Storage						
Package Propulsion System Storability						
Stress Corrosion Cracking						
Rocket Propellants						
Leak Detection						
Propellant Tank Quality Control						
Propellant Tank Materials						
Propellant Tank Fabrication Methods						

I-R

UNCLASSIFIED
Security Classification

AFRPL-TR-72-126

LONG-TERM STORAGE TESTING
OF PROPELLANT TANKAGE

H. M. WHITE, Capt, USAF

DECEMBER 1972

Approved for Public Release and Sale;
Distribution is Unlimited.

AIR FORCE ROCKET PROPULSION LABORATORY
DIRECTOR OF SCIENCE AND TECHNOLOGY
AIR FORCE SYSTEMS COMMAND
UNITED STATES AIR FORCE
EDWARDS, CALIFORNIA 93523

I-C

FOREWORD

This report covers the testing of liquid propellant tankage and propellant subsystems to evaluate their long-term storage characteristics. The testing is performed at the Air Force Rocket Propulsion Laboratory, Edwards, California, under Project No. 305810RJ. Testing is being conducted in test areas 1-40 and 1-36. The project engineer is Capt Howard M. White and the test engineer is MSgt John W. Wright. This report covers all work done under Project 305810RJ through June 1972. Previous reports written on this project are: AFRPL-TR-69-82, Long-Term Storability of Propellant Tankage and Components, AFRPL-TR-70-43, Long-Term Storability of Propellant Tankage and Components Interim Report No. 2, AFRPL-TR-71-20, Long-Term Storability of Propellant Tankage, and AFRPL-TR-71-113, Long-Term Storability of Propellant Tankage.

This technical report has been reviewed and is approved.

HOWARD V. MAIN
Chief, Engine Components Branch
Air Force Rocket Propulsion Laboratory

TABLE OF CONTENTS

<u>Section</u>		<u>Page</u>
I	INTRODUCTION	1
II	PROGRAM STRUCTURE	5
III	TEST FACILITIES	11
IV	PROCEDURES	12
V	DISCUSSION OF RESULTS	14
VI	CONCLUSIONS	23
VII	RECOMMENDATIONS	25
	REFERENCES	54
	AUTHOR'S BIOGRAPHY	56
 <u>Appendix</u>		
A	REPORT ON LEAK IN ALUMINUM ALLOY TANK	A-1
B	ALUMINUM ALLOY TANK FAILURE ANALYSIS	B-1
C	REPORT ON CRACK IN PIPE-TO-PLATE WELD	C-1

DD FORM 1473

LIST OF ILLUSTRATIONS

<u>Figure</u>		<u>Page</u>
1	Hygroscopic Action of N_2O_4 Vapor	26
2	3- by 6-Inch Containers.	27
3	One-Quart Alcoa Containers.	28
4	Arde Cylinders	29
5	Convair Storability Test Articles	30
6	Martin Storability Test Articles	31
7	Bullpup Tanks	32
8	Minimum Cost Design Tanks	33
9	ULPR Tanks	34
10	Agena Tank.	35
11	Solid State Bonded Tanks	36
12	Twelve-inch Arde Reversing Diaphragm Tank.	37
13	Arde Conospheroid.	38
14	Thiokol Rolling Diaphragm Tanks	39
15	All-Welded Stainless Steel Systems for ClF_5 and N_2O_4 Application	40
16	All-Welded Aluminum Systems for ClF_5 and N_2O_4 Application	41
17	Separable Connector Stainless Steel System for N_2O_4 Application.	42
18	Separable Connector Stainless Steel System for ClF_5 Application.	43
19	Separable Connector Aluminum Systems for ClF_5 and N_2O_4 Application.	44

LIST OF ILLUSTRATIONS (Cont'd)

<u>Figure</u>		<u>Page</u>
20	Prepackaged Feed Systems	45
21	Mariner Tanks.	46
A-1	Corrosion Products on Tank.	A-3
A-2	Corrosion Products Near Tank.	A-4
A-3	Leak Passage in Lug-to-Tank Weld.	A-5
A-4	Circumferential "Seam" on Interior Side of the Leak . .	A-6
A-5	Penetration of Corrosion into Weld from Outside.	A-7
A-6	Copper Deposited at Tip of Corroded Passage.	A-8
B-1	Corrosion Products on Girth Weld	B-3
B-2	Corrosion Products Removed from Region Indicated . . .	B-4
B-3	Crack in HAZ; Parallel to Girth Weld.	B-5
B-4	Crack Emanating from HAZ; Perpendicular to Girth Weld	B-6
B-5	Same as Figure 4; Weldment at Bottom of Photo	B-7
B-6	Cross Section of Crack - General Corrosion and Pitting, Exterior Surface.	B-8
B-7	Same as Figure 6, Except Closer to Weld.	B-9
B-8	Same as Figure 7. Circled Area is Location of Crack in Figures 4 and 5.	B-10
B-9	Same as Figures 6 and 7, Except Closer to Weld.	B-11
C-1	6061 Al Alloy Pipe Welded to 2021 Al Alloy Head Plate	C-2
C-2	One-Half of Crack in HAZ of Weldment in Figure 1 . . .	C-3

LIST OF ILLUSTRATIONS (Cont'd)

<u>Figure</u>		<u>Page</u>
C-3	Second Half of Crack in HAZ of Weldment in Figure 1	C-4
C-4	First Cross Section of Crack	C-5
C-5	Second Cross Section of Crack	C-6
C-6	Third Cross Section of Crack	C-7
C-7	Fourth Cross Section of Crack	C-8
C-8	Fifth Cross Section of Crack	C-9
C-9	Same as Figure 8. Crack Completed to Mating Gap of Pipe and Plate Hole.	C-10

LIST OF TABLES

<u>Table</u>		
I	GROUP I: SUMMARY OF RESULTS	47
II	GROUP II: SUMMARY OF RESULTS	49
IIIA	GROUP III: SUMMARY OF RESULTS	52
IIIB	GROUP III: SUMMARY OF RESULTS	53

SECTION 1

INTRODUCTION

Experience with liquid propellant rocket feed systems has shown that the leakage of oxidizers can occur and constitute a difficult problem under certain environmental conditions. In propellant tankage and certain types of feed systems, leakage is most frequently observed at or near weldments. It has been shown experimentally for N_2O_4 that when a vapor leak occurs (through a weldment microcrack for example), the result is drastically influenced by the relative humidity of the atmosphere surrounding the tank (Reference 1). If the relative humidity is on the order of 30 percent or lower, the vapor from the leak (principally NO_2) will dissipate into the atmosphere and does nothing to aggravate the leakage. If the environment surrounding the tank has a relative humidity of greater than 30 percent, the vapor from the leak will not dissipate into the atmosphere, but rather the vapor will hydrolyze with the water vapor in the air, forming dilute nitric acid on the exterior surface in the immediate vicinity of the original leak. Figure 1* clearly shows the resultant corrosion and discoloration that results from this process. The nitric acid has a further effect in that it will enlarge the original leak path by working inward toward the source of the leak. In time, small or even minute vapor leaks can become large liquid leaks, if they are allowed to proceed. Although a similar detailed experimental program has not been performed with the storable interhalogen oxidizers such as ClF_5 , an analogous process would be expected with hydrogen fluoride as the hydrolysis product. Failures of tankage with the above propellants lend credence to the foregoing hypothesis of the interhalogen oxidizers.

* Figures and tables are presented sequentially beginning on page 26.

In the past, the selection of materials for system applications has been based upon conventional fluid/material compatibility testing to determine discoloration pitting, weight gain or loss, notch sensitivity, stress corrosion cracking susceptibility, potential degrading effects on the propellant, and to a certain extent, a particular system contractor's experience with the fabrication of various materials likely to be used on the system in question.

Even after this thorough analysis and selection process, the material and/or processing used in the propellant tankage may not function properly or leaks may develop during the extended time required of many current liquid rocket systems. It is readily apparent that the use of conventional compatibility criteria, while certainly a part of the material selection process, is not in and of itself suitable for the selection of materials for the extended storage of liquid rocket propellants when fabricated into system tankage.

The major limitation on interpreting long-term storability effects in a realistically severe storage environment is the inability of conventional fluid/material compatibility criteria to predict leakage. Small, undetected pinholes or microcracks could be formed by an attack by the propellant or grain boundary precipitates and weld inclusions that might never be detected through weight gain or loss calculations. Furthermore, the possibility of such defects forming is greater in the high-strength, limited-weldability materials frequently used in liquid rocket propellant tankage. The size and methods of producing test specimens used in compatibility work eliminates many of the manufacturing and quality control procedures associated with production systems. Smooth, polished samples, welded or unwelded, are not comparable to fabricated tankage material. The experience of the Titan II weapons system is an excellent example of the inability to translate basic fluid/material compatibility data to fabricated tankage material. In that case, the tankage material,

2014-T6 aluminum, is compatible with the oxidizer, N_2O_4 MIL-P-265398; however, in the field, the missile was plagued by leakage, frequently occurring in the tankage weldments or heat-affected weld zone, in a humid environment (<30 percent relative humidity).

Long periods of storage may affect the functional performance and system reliability of prepackaged propulsion systems. To factor the storability variable in an adequate manner, many areas should be considered. Storage conditions must be selected that are representative of operational system conditions. Such factors as temperature and humidity play an important role. A detailed propellant analysis before and after testing is required to evaluate the effects of storage on the propellant. The cleanliness levels of the test articles must be known for reasons of safety, but equally important, for evaluating the process which was used to effect this cleaning level. Materials and chemicals used for cleaning may have an effect upon system life. In the same manner, manufacturing processes and quality control standards may impose many unforeseen conditions which vary from one manufacturer to another. Throughout the fabrication of tankage (i. e., during forming, welding, inspection and testing), all data should be available for a meaningful post-test failure analysis in the event of a test article failure. Metal preparation prior to welding may make the difference between a satisfactory or unsatisfactory weld with regard to its ability to contain propellant without leakage. Helium leak testing of systems and the technique of leak testing are very important since small leakage (which cannot be detected by X-ray or dye-penetrant inspection) can lead to propellant leakage under adverse environmental conditions. These very small leaks can be detected through helium leak testing. The above variables must be known and controlled in a meaningful storability investigation.

Although there has not been a storability problem of the magnitude of the oxidizer storability problem on the Titan II, present and future

monopropellant satellite systems require long-term storability data so their system designers can design systems with confidence with 5- to 10-year mission lives. In the long-term storability of hydrazine, the failure mode is one of propellant decomposition rather than leakage. This decomposition is catalyzed by impurities in the materials in contact with the propellant; therefore, the tanks must be prepassivated or, in the extreme, be allowed to self-passivate when loaded with propellant. The use of standard fluid/material compatibility tests will demonstrate basic propellant/material compatibility. The premise in this fuel storability program is that completely fabricated tankage must be loaded with propellant and placed in extended storage to permit evaluation of fabrication variables in determining those tankage materials that are suitable for long-term storage of hydrazine-type fuels with negligible pressure rise.

SECTION II

PROGRAM STRUCTURE

To bridge the gap between laboratory compatibility samples and the long storability required of operational liquid systems, the Air Force Rocket Propulsion Laboratory (AFRPL) has been conducting, for the past 5 years, a program entitled "Packaged Systems Storability." This program deals with the long-term (5 to 10 years) storage of tankage, components and integrated propulsion feed systems with earth-storable fuels and oxidizers. Tankage materials under investigation include aluminum, steel and titanium alloys. Test systems include tankage, and complete feed systems including tankage, components, expulsion devices and gas pressurization systems. Previously tested under this program were integrated systems consisting of tankage and feed system components.

The test systems encompassed by the program are divided into three basic groups: (1) small containers, (2) representative-type tankage, and (3) tankage with associated expulsion devices and/or feed system components.

GROUP I: SMALL CONTAINERS

All tankage in this group is of approximately 1-quart capacity manufactured from aluminum and steel alloys. The purpose for using this tankage group is to evaluate a particular problem or to evaluate a promising material. These test articles are relatively cheap and serve as excellent "screening" devices. Because of their small size, these containers cannot duplicate the manufacturing and quality control problems associated with larger-size tanks. There are three types of tankage in this group.

1. 3- by 6-Inch Containers

There are 28 containers of this type in the program. All containers are manufactured of 2014-T6 aluminum. Containers manufactured by McDonnell Douglas, General Dynamics, Martin and North American Rockwell (seven from each firm) were tested. These were a direct offshoot of the leakage problem encountered with the Titan II weapons systems, and were indicated to determine if N_2O_4 (Specification MIL-P-26539) and 2014-T6 aluminum was an "unstorable" propellant/material combination, or if the Titan II leakage problem was solely a Martin fabrication/quality control problem. Figure 2 shows tanks of this type.

2. Alcoa 1-Quart Containers

These tanks are Alcoa standard containers for material compatibility testing and are used to evaluate the storability of various aluminum alloys with N_2O_4 and ClF_5 . The aluminum alloys are: 2014-T6, 2021-T6, 2219-T81, 3003, 5456 T-6 and 7007-T6. Tankage of this type is shown in Figure 3.

3. Arde Cylinders

These are small containers developed by Arde, Inc., as high-pressure CO_2 cylinders of AISI 301, cryogenically stretch formed stainless steel. They are used to evaluate the storability of this material in both aged and unaged condition with N_2O_4 , ClF_5 and N_2H_4 . They are illustrated in Figure 4.

GROUP II: REPRESENTATIVE TANKAGE

The tankage in this group varies in size from 10-gallon capacity up through a full-scale Agena tank, and encompasses tankage fabricated solely for use as test articles in this program as well as surplus tankage

from actual operational systems. The tankage in this group is fabricated through current or advanced state-of-the-art methods, and the types of fabrication and quality control problems encountered during the course of manufacture of this tankage group would likely be encountered during the manufacture of an operational liquid rocket system. There are three basic types of tanks in this tankage group.

1. Storability Test Articles

These are tanks of 10- to 15-gallon capacity procured especially for use in this program. These are tanks which were either manufactured by Convair (Figure 5) or Martin (Figure 6) as a part of several procurements over the course of several years. The tankage is manufactured from several aluminum, steel and titanium alloys. It was manufactured using large-scale production methods, and includes dome, girth, cylindrical, and longitudinal welds characteristic of large tankage design. Manufacturing process records, X-ray, photographs, inspection logs and metallurgical samples of welded and unwelded materials were delivered with the tanks to serve as documentation. The tanks are loaded with N_2O_4 (Specification MSC-PPD-2A), ClF_5 and N_2H_4 .

2. Existing Tanks

These are tanks that were donated or were surplus to other AFRPL programs, or tankage from operational liquid rocket systems. The tanks are as follows:

a. Bullpup Tanks. These are three 2014-T6 aluminum tanks (Figure 7) manufactured by the Reaction Motors Division of the Thiokol Chemical Corp., and are loaded with N_2O_4 (Specification MSC-PPD-2A).

b. Minimum Cost Design Tanks. These are four tanks of HY-140 steel and six tanks of Maraging-200 steel (Figure 8). They were

designed to demonstrate 90-day storability of N_2O_4 (Specification MIL-P-26539) and UDMH as part of the AFRPL Minimum Cost Booster Program.

c. ULPR Tanks. These tanks were surplus from the AFRPL Ultra Low Pressure Rocket (ULPR) Program (Figure 9). They are two 2219-T81 tanks and are loaded with N_2O_4 (Specification MSC-PPD-2A).

d. Agena Tank. This was a tank utilized to demonstrate 90-day storability of N_2O_4 (Specification MSC-PPD-2A) as part of the Agena E program (Figure 10). The standard Agena oxidizer is IRFNA.

3. Solid State Bonded Tanks

These tanks were hardware delivered under an AFRPL program with Martin to demonstrate the explosive bonding technique in the fabrication of tankage. Two configurations (Figure 11) of tankage were fabricated from A286 stainless steel and one configuration was fabricated of 65A titanium. The A286 tankage is loaded with N_2O_4 (Specification MSC-PPD-2A) and ClF_5 , while the Ti-65A tankage is loaded with N_2O_4 (Specification MSC-PPD-2A).

GROUP III: EXPULSION SYSTEMS AND COMPONENTS

In an operational system, an expulsion device is often integrated into the tankage to ensure that single-phase liquid is fed to the engine. Since this is the case, the storability of this combination must be evaluated. Also, any liquid rocket feed system has components associated with it, and an assessment of the component storage characteristics is necessary to design properly a liquid rocket propulsion system. Test articles in this group represent an attempt to assess the storability of components and expulsion systems. The following are the test articles in this group.

1. Metallic Reversing Diaphragms

There are two types of tankage in testing associated with its expulsion device (Figures 12 and 13). In all cases the tankage is AISI 301, cryogenically stretch-formed stainless steel. One group of six tanks 12 inches in diameter has a 304L stainless steel reversing diaphragm and is similar to that developed for LITVC tankage on the third stage of Minuteman III. These test articles are loaded with N_2O_4 (Specification MSC-PPD-2A), ClF_5 and N_2H_4 . Two 28-inch-diameter conospheroid tanks are also being tested with N_2O_4 (Specification MSC-PPD-2A). These tanks have an AISI 321 stainless steel expulsion diaphragm. All of this tankage was manufactured by Arde, Inc.

2. Rolling Diaphragm

These are three tanks fabricated by the Reaction Motors Division of Thiokol Chemical Corp. (Figure 14). These tanks have an 1100-0 aluminum expulsion diaphragm bonded to a Maraging-200 steel shell and are 30 inches in diameter. Test articles are loaded with N_2O_4 (Specification MSC-PPD-2A).

3. AFRPL Integrated Systems

The tanks here are similar to those described under Group II Storability Test Articles, but, associated with the tank on tubing located on the top and bottom, are fluid components normally found in liquid rocket systems. The tankage is either 2219-T81 aluminum or AM350 steel. Fluid components consist of a pressure switch, explosive valve and burst disk. Fittings are AFRPL mechanical fittings (MIL-F-27417) and TIG welded joints. Since tankage material and component materials are of both aluminum and steel, intermetal transitions are made using both mechanical fittings and solid state bonded transition joints. These systems are shown in Figures 15 through 19.

4. Prepackaged Feed Systems

These are test articles developed by General Dynamics Corp., and consist of 2219-T86 EB welded tankage, with either a rolling diaphragm or surface tension screen expulsion device, and either a liquid propellant gas generator (LPGG), solid propellant gas generator (SPGG) or high-pressure stored gas device (GD) pressurization systems. Systems are loaded with N_2O_4 (both MIL and MSC specifications), ClF_5 and MHF_5 . They are shown in Figure 20.

5. Mariner Tanks

These test articles are three flight-weight tanks surplus of the Jet Propulsion Laboratory's Mariner Mars 1969 program. These tanks are identical to the Mariner tanks with the exception of the use of an improved elastomeric material (AF-E-332) as the expulsion bladder. The test articles are loaded with N_2H_4 . They are shown in Figure 21.

SECTION III

TEST FACILITIES

Storage testing of tankage loaded with oxidizer is conducted in a metal Quonset hut storage test building equipped to provide a constant controlled environment of $85 \pm 5^{\circ}\text{F}$ and 85 ± 5 percent relative humidity. The oxidizer storage test facility is insulated by spray-in-place foam (polyurethane). Environmental conditions are maintained by two evaporative coolers and immersion water heaters. Safety provisions in this facility consist of a firex-type water deluge system, large water drain piping, fire detectors, closed circuit television monitoring, and a continuous toxic vapor detector. The toxic vapor detector is also incorporated into an automatic conditioner shutdown and scrubbing system, which operates when an excess of oxidizer vapor is detected by the facility toxic vapor detector. This feature minimizes the damage to test articles that would result when a leak develops in a test article.

The testing of fuels is conducted in a building equipped to provide controlled temperatures and uncontrolled relative humidity. The temperature inside the fuel facility can be controlled at any temperature between $+65^{\circ}$ and $+165^{\circ}\text{F}$. Temperature conditioning is maintained by a heating and refrigeration system. The building is insulated with a fire retardant, spray-in-place insulation. The facility is also equipped with a trace gas analyzer to detect any unnoticed propellant spillages. The fuel vapor detector is not incorporated into an automatic conditioner shut-down system, as is the oxidizer vapor detector.

SECTION IV PROCEDURES

The test articles utilized in this program are procured from aerospace contractors and are fabricated with tooling and fabrication methods currently in use in liquid rocket systems. The primary responsibility for quality control and quality assurance of the test articles is vested in the manufacturer of the test article. To ensure high-quality test articles for use in this program, procedure specifications governing all aspects of the test article manufacture, inspection and cleaning were either generated or identified for use in the procurement of all test articles in this program.

All test articles with the exception of the integrated pressurization/tankage/expulsion systems procured from General Dynamics, are leak checked by helium mass spectrometer and verified to be clean at the AFRPL to ensure against the development of leaks and the introduction of contamination during shipment of the test articles from the manufacturer.

Following this, the test articles are loaded with propellant and placed in the appropriate storage facility for storability testing. The oxidizer tankage is monitored for leakage. The fuel tankage is monitored for excessive pressure rise.

Oxidizer tankage is removed when evidence of leakage is found. This leakage is detected either through observation of an actual liquid leak, or the detection and location of a vapor leak by means of the facility toxic vapor detector. This instrument can also be configured as a "sniffer" to pinpoint leakage.

In the event of excessive pressure rise in a fuel tank, the tank is vented and propellant and ullage gas samples are taken. Tanks which

exhibit continued pressure rise are removed from testing and analyzed to determine whether the pressure increase was due to an isolated instance or is indicative of a lack of storability of the material.

SECTION V
DISCUSSION OF RESULTS

A summary of all test articles and the results to date are presented in Tables I through IIIA. Detailed analysis of all test article failures in this program are presented in the appendices of the reports published during this program (References 2 through 5). The failure analyses in the appendix to this report cover those analyses performed from July 1971 through June 1972. A general discussion of the results obtained from each tankage group is presented below.

GROUP I: SMALL CONTAINERS

1. 3- by 6-Inch Containers

This type of tankage is no longer in test. Of the 28 containers that were placed in storage, 23 were still loaded with propellant when the test was terminated. The failure of four of the five tanks that were withdrawn from storage testing can be attributed to poor container end-plate joint design, which in turn resulted in poor weld penetration (Reference 2). The failure of the other vessel was due to nitric acid attack on the exterior surface which led to eventual development of stress corrosion cracking and vessel failure. The failure analysis performed on this vessel does not indicate whether the initial nitric acid attack resulted from N_2O_4 vapor leak in this vessel or from N_2O_4 leaking from some other vessel in the storage facility and then condensing on the vessel in question.

The 3- by 6-inch container testing was terminated for three reasons. First; at the time that testing on these containers was terminated (5 March 1971), a total of 1522 days of testing had been accumulated on the 23 containers under test. It was determined that sufficient storage had been accumulated to demonstrate the storability of the N_2O_4 /2014-T6 aluminum combination. Second; the floor space in use at the facility was

needed for more representative types of test articles. Finally, the testing of the 3- by 6-inch containers was terminated because the basic design of the containers was a poor one, and as a result, only a small amount of data pertinent to flight-type systems was being gathered.

2. Alcoa 1 Quart Containers

Testing of containers loaded with N_2O_4 was suspended on 5 March 1971. As of that date, no leaks had been detected in any of the 16 containers being tested with N_2O_4 . The principal reason for withdrawing these containers from testing was to utilize the floor space in the facility taken up by these containers for more advanced test articles. A secondary consideration was that all but two of the aluminum alloys, 5456 and 7007, were represented in other test articles in this program.

Testing of Alcoa containers loaded with ClF_5 was terminated in June 1972. Of the 37 test articles originally put in storage, 24 remained at the time testing was terminated. Failure analysis of these tanks withdrawn from testing indicated that the failure mechanism was one of stress corrosion cracking initiated by the presence of dilute HF on the external surface of the test article. As with the above 2014-T6 aluminum 3- by 6-inch container, the failure analysis cannot indicate whether the HF resulted from a ClF_5 vapor leak in some nearby tank/container with the HF condensing on the container which leaked, or from the leaking container itself. In 1970, four 2014-T6 aluminum tanks were withdrawn from storage testing with bad cracks in the fitting boss weld, but prior to actual failure, as evidenced by leakage. The analysis of the cracking in these tanks (Reference 4) would seem to lend credence to the argument that the cause of cracking (determined to be stress corrosion cracking) may have been due to the HF condensed on the surface, or that the HF was from some tank other than the one in which the stress corrosion cracking developed. The foregoing argument is discussed further in the failure analysis report of a Group II tank.

3. Arde Cylinders

Of the 40 test articles placed in storage, N_2O_4 (5 aged, 5 unaged), ClF_5 (5 aged, 5 unaged) and N_2H_4 (10 aged, 10 unaged), only one, an aged vessel loaded with ClF_5 was removed prematurely from storage. This failure was the result of an environmentally induced stress corrosion crack, and occurred over a 2-day period when approximately 7.5 gallons of ClF_5 were released into the oxidizer test facility. This large release of ClF_5 resulted in a high concentration buildup of HF in the facility, and was at least partially responsible for the leakage of this test article. The reason for this large release of ClF_5 will be discussed later under Group III tankage, AFRPL Integrated Systems. The remaining oxidizer loaded tankage was removed on 27 July 1972 after completing five years of leak free storage. The N_2H_4 loaded tankage continues in storage, and has exhibited no excessive pressure rise after approximately 10 months storage at $140^\circ F$. Discounting this one leak, it would appear that the 301 cryo-stretched material is an excellent material for use in liquid rocket tankage.

GROUP II: REPRESENTATIVE TANKAGE

1. Storability Test Articles

The tankage failures encountered during testing of this group of test articles are probably the most significant of the entire program. These failures give a firm indication as to the areas where improvements can be made to increase the storability of various propellant/material combinations.

During this program, five titanium vessels (three of the 6Al-4V titanium and two of 5Al-2.5Sn titanium) failed as a result of loading with "brown" N_2O_4 (MIL-P-26539B). All of the titanium tanks leaked within 35 days after loading with N_2O_4 . Both the 6Al-4V and the 5Al-2.5Sn titanium alloys were in the annealed condition when tested. The use of

"green" N_2O_4 (Specification MSC-PPD-2A) was considered at the time of loading the tanks; however, the stress levels in the tankage, based on the nominal loads and thickness, were considerably below the threshold for the stress corrosion cracking reported (16 ksi nominal stress versus 40 ksi reported threshold). Also, the test temperature was significantly below the temperatures at which problems were encountered (85° versus $110^\circ F$). On the basis of the above considerations, stress corrosion cracking was not thought to be significant. Failure analysis of the five tanks (References 2 and 3) indicates that stress corrosion cracking in the weld area and heat-affected zone was responsible for the failure of these tanks. Currently, there are three 6Al-4V tanks, similar in design to the 5Al-2.5Sn tanks described above, in the program which are loaded with "green" N_2O_4 (Specification MSC-PPD-2A). These tanks have been tested for approximately three years with no indication of leakage. Based on the foregoing, the use of "green" N_2O_4 is encouraged for all systems utilizing titanium.

A second type of failure encountered with high frequency during the storage testing of these test articles is hot-short cracking in and around the area of double-pass welds. These may either be start-stop zones or repair welds. In either case, there is a high probability of hot short cracks which lead to vessel failure. To compound the problem further, these defects are often missed during the course of normal quality control operations. Failures of this type are indicated in the failure analyses presented in References 2 and 3. Quality control operations should be structured so as to decrease the chances of such a defect slipping through.

A common type of failure encountered in this program, and also with a group of test articles, is failure due to environmentally induced stress corrosion cracking. This failure mode has been documented in failure analysis performed by Martin-Marietta Corporation and in-house

by the AFRPL Metallurgical Laboratory (References 3 and 4). This is the failure mode referred to earlier in the discussion of the failure of 1-quart Alcoa containers loaded with ClF_5 . In the above vessel failure mode, stress corrosion cracking is induced by diluted acid on the exterior surface. The acid comes from the hydrolysis of oxidizer vapors whose source is a small leak in a vessel in the storage facility. Whether the source of the leak is the actual vessel that fails or some other vessel is open to question. There is some experimental evidence to support both conclusions. The work done by Martin (Reference 1) as part of the Titan II leakage problem would indicate that vapor leakage in a vessel would in time lead to a liquid leakage in that vessel. Failure analysis done by Martin-Marietta on two vessels containing N_2O_4 revealed the presence of fluorides on the exterior surface (Reference 2). The only source of fluorides in the storage facility was the ClF_5 stored in the building. This would in turn indicate that ClF_5 vapor, whose source was a ClF_5 vapor leak in another test article, hydrolyzed in the humid environment of the test facility to form HF. The HF condensed on the vessels containing N_2O_4 and initiated stress corrosion cracking which led to test article failure.

Of the failures classed as due to environmentally induced stress corrosion cracking, a majority occurred in tankage which was fabricated from either 17-7PH or AM350 steel and loaded with ClF_5 . In no case were nitrates (indicating nitric acid/ N_2O_4 attack) found. This would indicate that the use of either 17-7PH or AM350 steels with ClF_5 would be unwise.

The only way to eliminate this type of failure would be to isolate each tank from every other tank. In view of the extensive facility modification required to do this, this alternative is not being considered at this time. It is hoped that instead, the installation of toxic vapor detectors (as discussed in Section III) will substantially reduce the incidence of

this type of failure by clearing the facility whenever a concentration of oxidizer vapor is detected.

One failure encountered in this program indicates poor design on the part of the test article manufacturer. This is documented in Reference 3. In this case, 7039-T6 aluminum vessel with N_2O_4 (MIL-P-26539 specification) failed because of stress corrosion cracking along the short transverse grain direction. After failure, a stress analysis was performed, and excessive stress was found to exist along that grain orientation. A careful review of this design would have prevented this vessel failure.

Over the past nine months, eight aluminum test articles loaded with ClF_5 have been withdrawn from the program as a result of leakage at tube/connector welds. The connector in all cases was a 1/2 inch aluminum, threaded, AFRPL connector (MIL-F-27417). Review of the X-rays of the welds that leaked have shown no apparent defects. A detailed failure analysis has not been performed; however, based on the large number of failures (eight) and the relatively short period of time, the use of this fitting is not recommended with ClF_5 .

Previous reports on this program (References 3, 4, and 5) have reported the unsuitability of 17-7PH and AM350 steels for use with hydrazine at elevated temperatures. This conclusion was based on pressure rise data collected over about a one year period, and was principally the result of pressure spikes noted when the facility temperature was increased. Following the period above, hydrazine testing was terminated to allow for facility modification, and has since been resumed. Currently, ten months of real time data has been accumulated with no indication of excessive pressure rise with either 17-7PH or AM350. No pressure spikes have been noted as a result of temperature fluctuations in the facility. A review of the data and the procedures utilized when the erratic pressure histories were noted, indicates that the excessive

pressure was probably the result of insufficient ullage. No other excessive pressure rises with other materials have been noted in the program, either during the initial testing or during the current testing.

2. Existing Tanks

a. Bullpup Tanks. All three continue in storage. They have accumulated over 4 years of storage.

b. Minimum Cost Design Tanks. Of the ten tanks of this type, two of the HY-140 tanks were loaded with N_2O_4 and two with UDMH. Three of the Maraging-200 tanks were loaded with N_2O_4 and three with UDMH. The storage testing was to demonstrate a 90-day loaded pad life without leakage or excessive pressure rise. The 90-day pad life was demonstrated.

c. ULPR Tanks. Testing of these tanks was terminated after approximately 3 years in storage. At the time the tanks were removed from testing, no leaks had developed. These tanks were removed to provide floor space for more advanced test articles.

d. Agena Tank. This tank was tested to demonstrate a 90 day storability with N_2O_4 , in support of the Agena E (Advanced Agena) Program, which contemplated a change from IRFNA to N_2O_4 . The requirement was met and the tank was removed from testing at the end of that time.

GROUP III: EMPULSION SYSTEMS AND COMPONENTS

1. Metallic Reversing Diaphragms

All test articles of this type loaded with oxidizers are still being tested with no leakage observed. Those test articles loaded with hydrazine were withdrawn from testing and have been returned to testing after

completion of fuel storage facility modification discussed above. During the storage testing of these articles with hydrazine, no excessive pressure rise was noted.

2. Rolling Diaphragm

Of the three test articles initially placed in storage testing, two remain. The third developed a leak after 3 months of storage testing. The leak was due to failure of a hub-to-diaphragm weld. This failure points to an area where increased quality control inspection would be in order.

3. AFRPL Integrated Systems

Testing of these articles has been suspended and will not be resumed. This action is a result of the extensive damage sustained by the fluid components when 7.5 gallons of ClF_5 were released into the facility. The ClF_5 was released when a manual weld in the tubing on the bottom of an AM350 steel tank failed because of a tungsten inclusion of the weld. This release of ClF_5 caused leaks in the above AM350 tank and an Arde cylinder also loaded with ClF_5 . Following the leak, all test articles of this type were removed from testing and examined. It was then determined that the fluid components, particularly the pressure switches and transition joints, sustained unacceptable damage. At this time, the installation was reconfigured to allow testing of the tanks alone. The fluid components were retained for analysis. The tanks associated with these test articles are now reported in Group II-Storability Test Articles. Testing of these tanks was resumed in September of 1971.

4. Pre-packaged Feed Systems

To date, there have been no failures in those systems loaded with MHF-5. Failures that have occurred in systems loaded with ClF_5 have been the result of propellant leakage. Leakage has occurred through

either the fill tube, which was welded shut (Reference 2), or through voids in the gas side burst disk (Reference 4). There are no more systems loaded with ClF₅ under test.

There has been one leak in an N₂O₄ system due to a fill tube leak. Also, seven systems have been withdrawn from testing because of a failure in a regulator. The failure was due to environmentally induced stress corrosion cracking (Reference 5). Both N₂O₄ and ClF₅ hydrolysis products were found on the surface of the regulator.

5. Mariner Tanks

No excessive pressure rise has been noted in these test articles. This is undoubtedly a result of the short period of time these test articles have been in storage (about one month). Since AF-E-332 is not inert to hydrazine, the storage life of these articles is expected to be one year, based on pressure rise and material degradation criteria.

SECTION VI

CONCLUSIONS

The Package Systems Storability Program has accumulated a significant amount of storage time, and sufficient data have been collected so that tentative conclusions and recommendations can be made. The conclusions and recommendations are based on failure analysis reported in earlier progress reports and general observations made during the program.

It has been observed that double heat welds which occur at start/stop points and at weld intersections or at weld repairs lead to a high incidence of hot short cracks. This condition is especially prevalent in manual repair welds because of poor control of heat input. It is therefore concluded that quality control criteria for acceptance of welds be made stringent enough, especially in the case of repair welds, to preclude the acceptance of defects.

This program has demonstrated the influence of propellant chemistry on storability. In five separate cases, tankage fabricated from titanium experienced failure due to stress corrosion cracking (at stress levels below the generally accepted threshold for stress corrosion cracking) in 1 month or less when loaded with "brown" N_2O_4 (MIL-P-26539 Specification Grade). At the present time, there are three titanium test articles with more than 2 years of successful storage time, loaded with "green" N_2O_4 .

In one instance, it was noticed that because of poor tank design, excess stress levels existed in the short transverse direction of the material. This led to tank failure due to stress corrosion cracking, indicating that tank design must be carefully scrutinized to preclude significant stress levels along stress corrosion sensitive grain orientations.

The presence of trace amounts of tungsten resulted from inclusions produced by the tungsten inert gas (TIG) or heliarc welding process. This in turn resulted in the rapid development of weld leakage in welded tube joints used with ClF_5 . This is because the tungsten was removed in the form of gaseous tungsten fluoride, and in turn resulted in a leak path. The process is somewhat analogous to intergranular corrosion. The problem of tungsten in fluoride service points up the need for strict quality control and the rejection of any weld showing traces of tungsten inclusions.

SECTION VII

RECOMMENDATIONS

In line with the conclusions presented in the preceding section of this report, tentative recommendations can be made with regard to improving the storability characteristics in liquid rocket propellants.

It is recommended that quality control systems be reviewed to preclude the possibility of the acceptance of tankage with poor design characteristics (i. e. , excessive stress along sensitive grain orientations) or questionable welds (i. e. , hot short cracks in double-pass regions, or trace inclusion).

It is also recommended that, in the case of titanium tankage loaded with N_2O_4 , the propellant have sufficient NO content to prevent initiation of stress corrosion cracking.

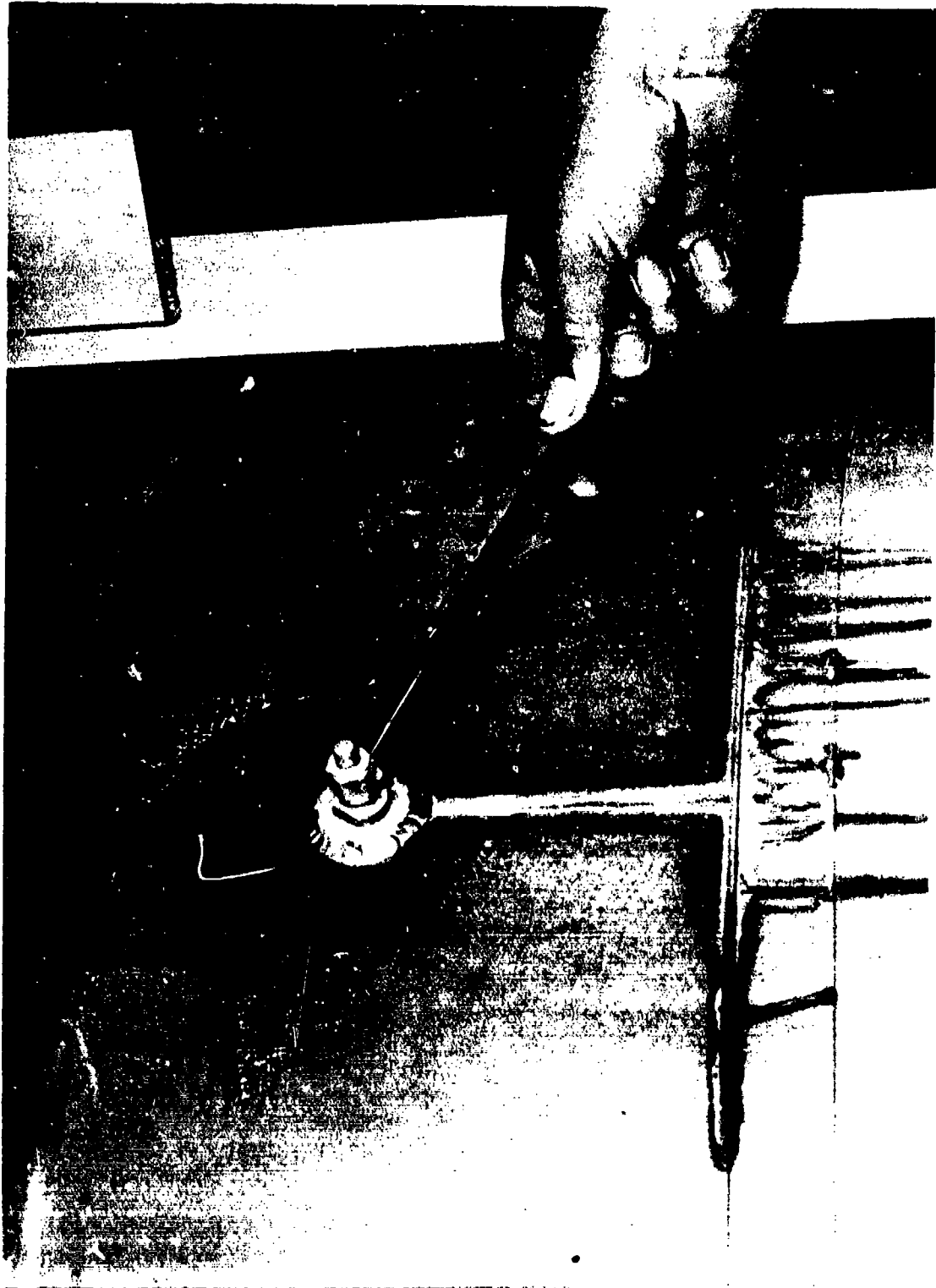

Figure 1. Hygroscopic Action of N_2O_4 Vapor

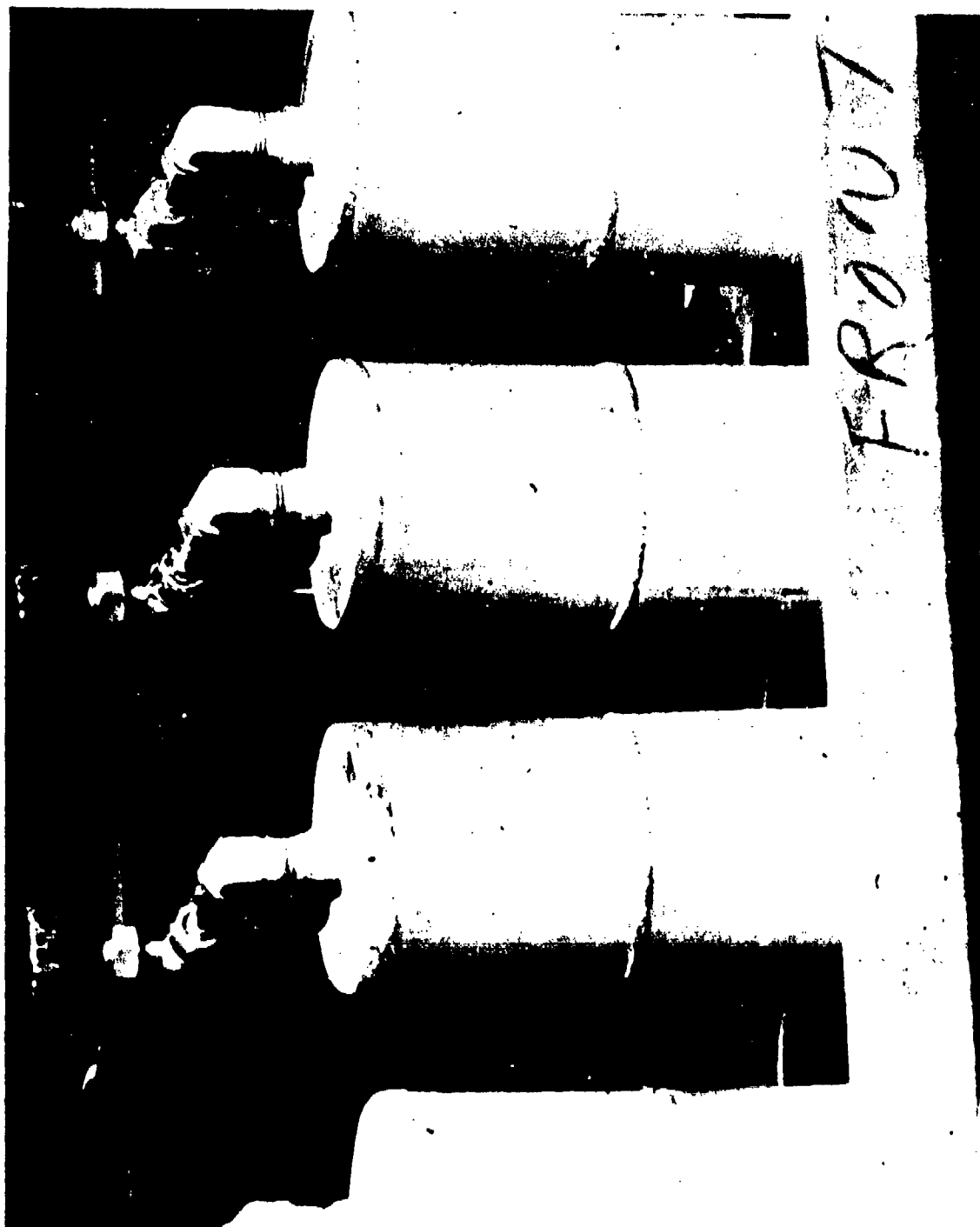

Figure 2. 3 - by 6-Inch Containers

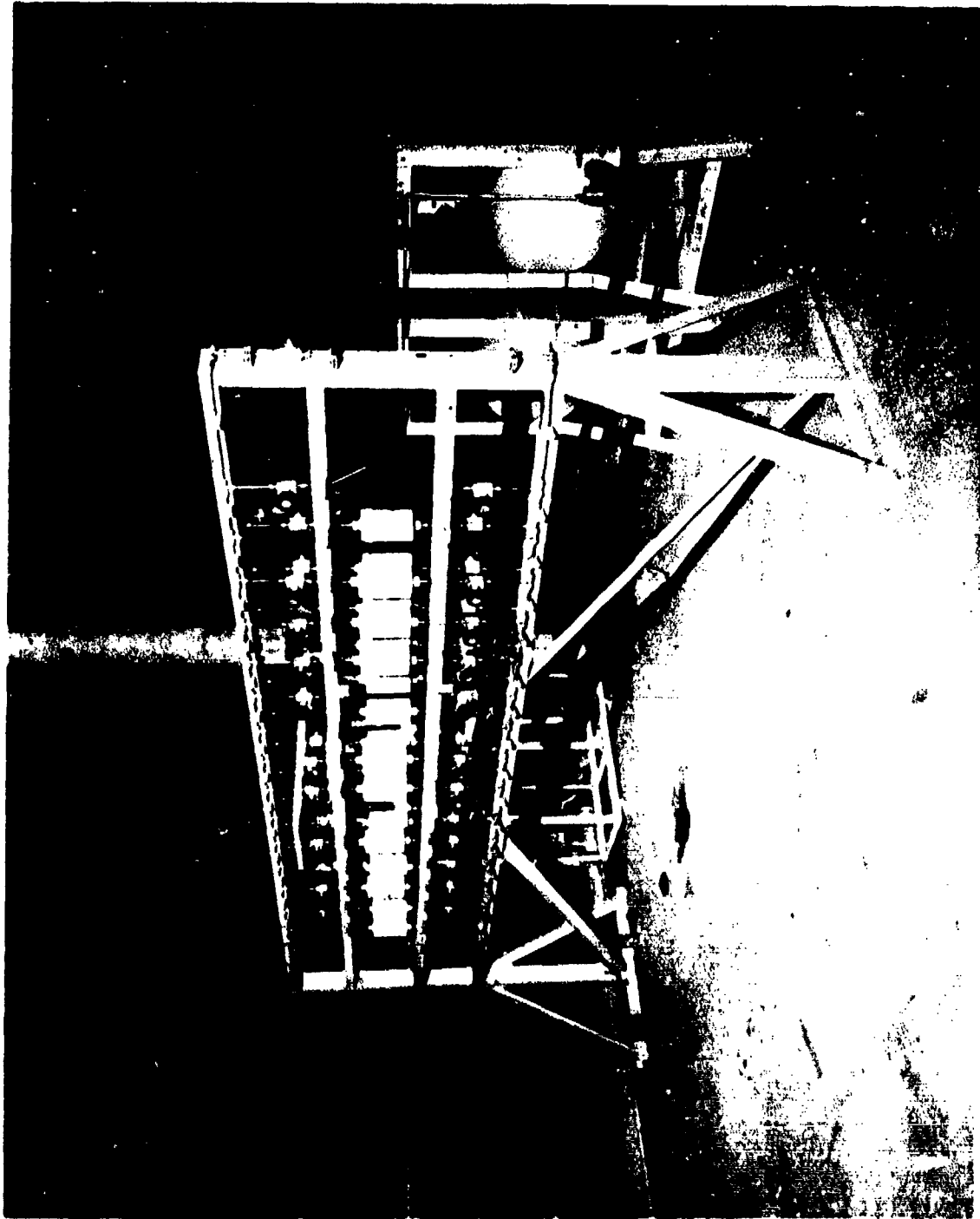

Figure 3. One-Quart Alcoa Containers

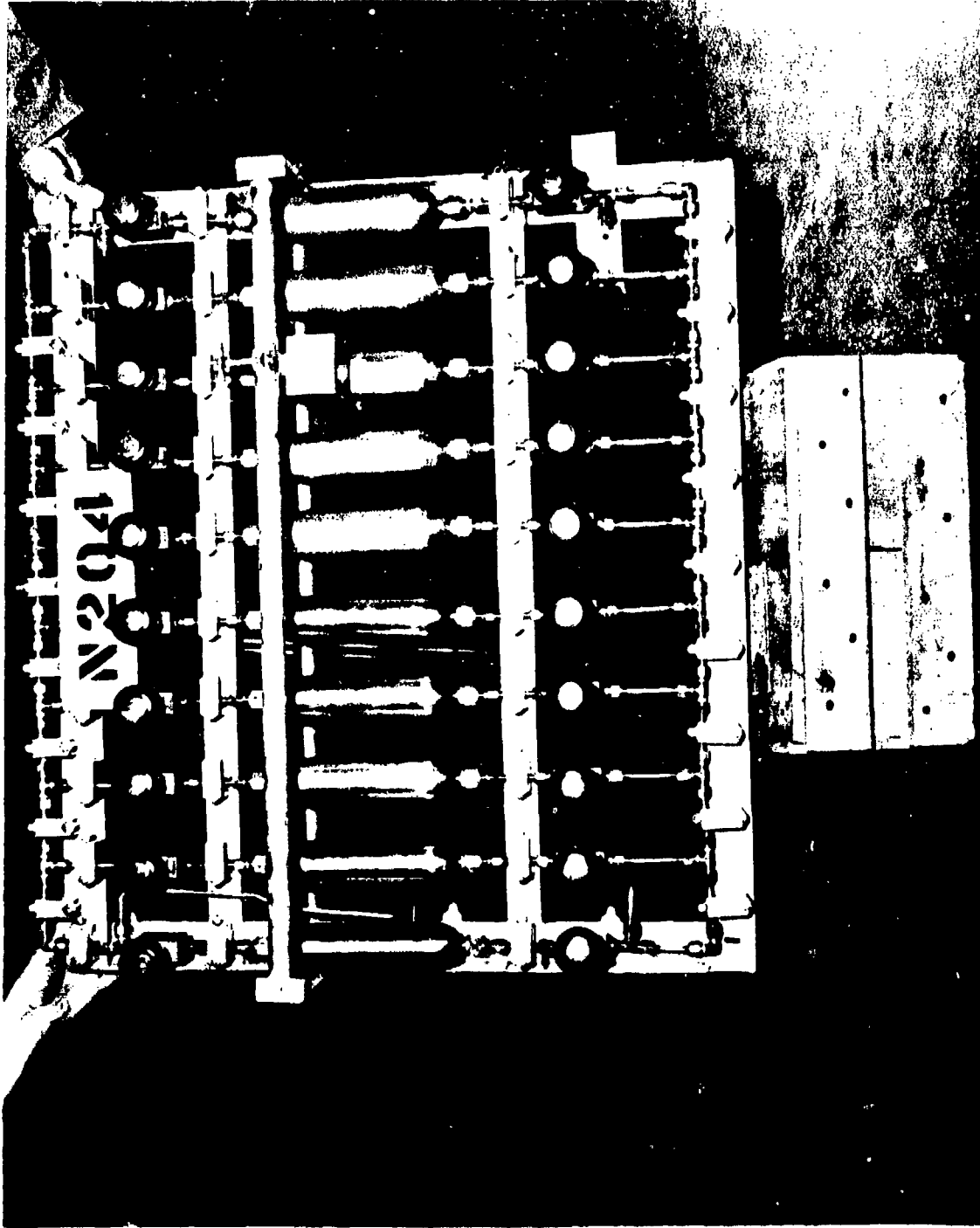

Figure 4. Arde Cylinders

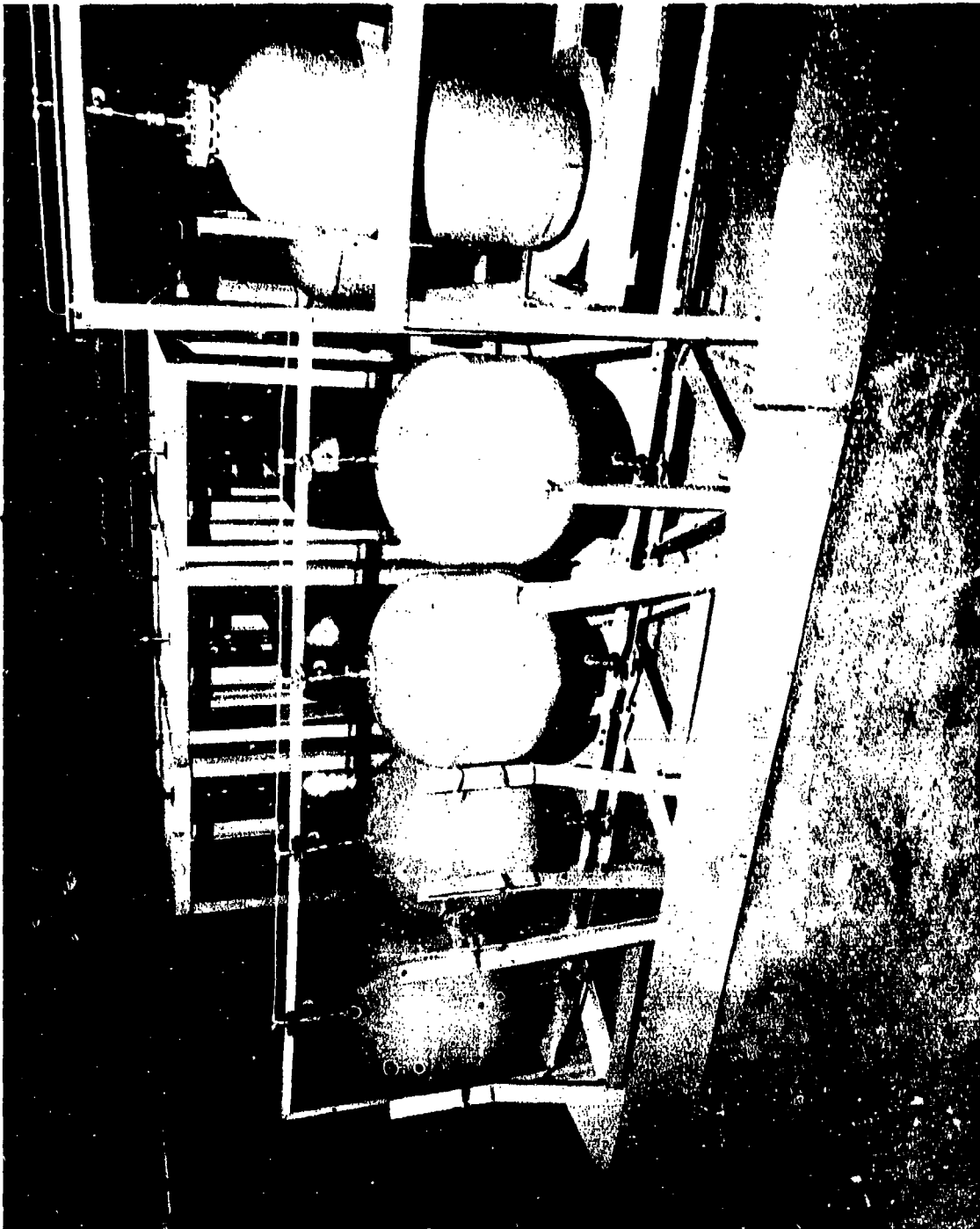

Figure 5. Convair Storbility Test Articles

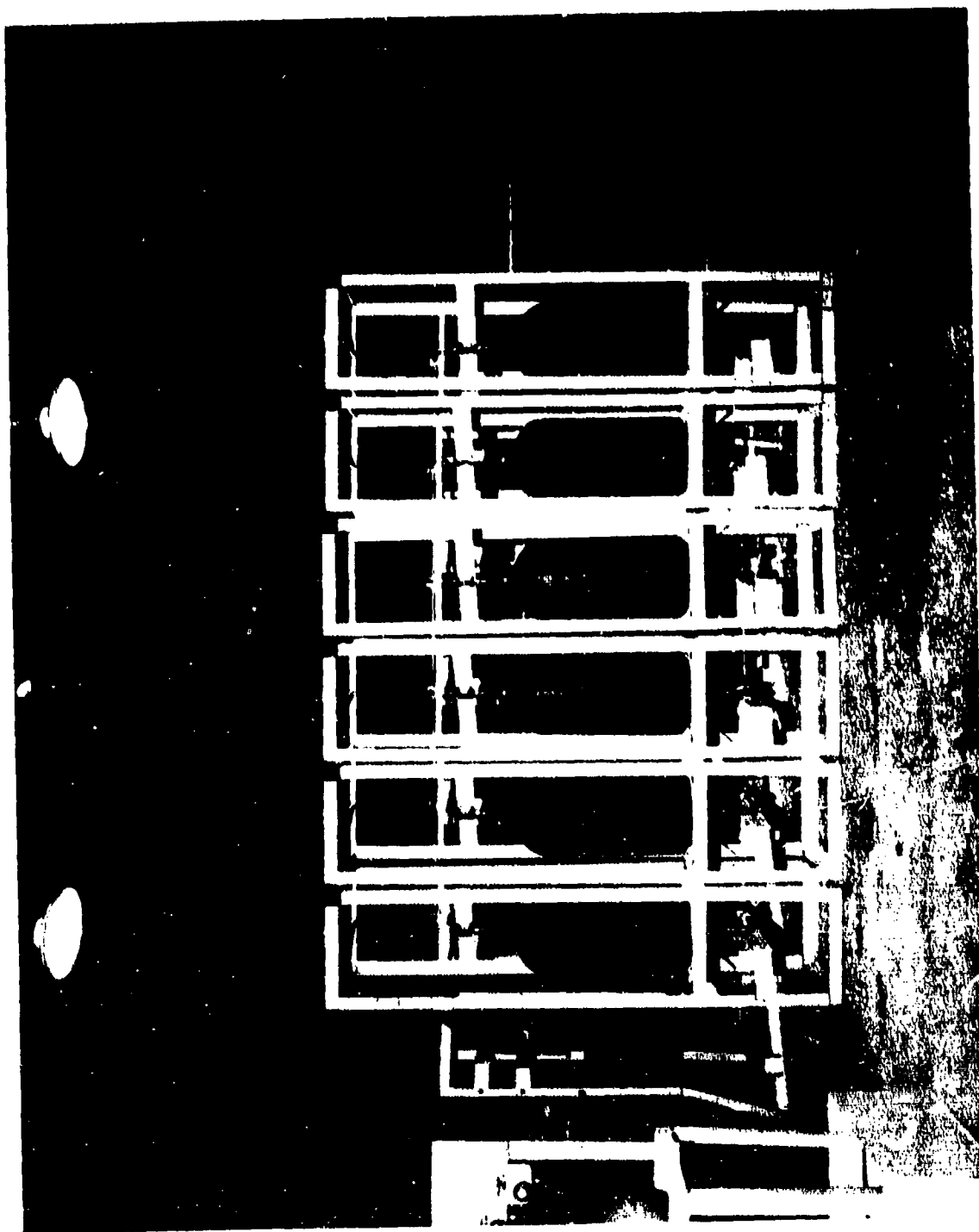

Figure 6. Martin Storbility Test Articles

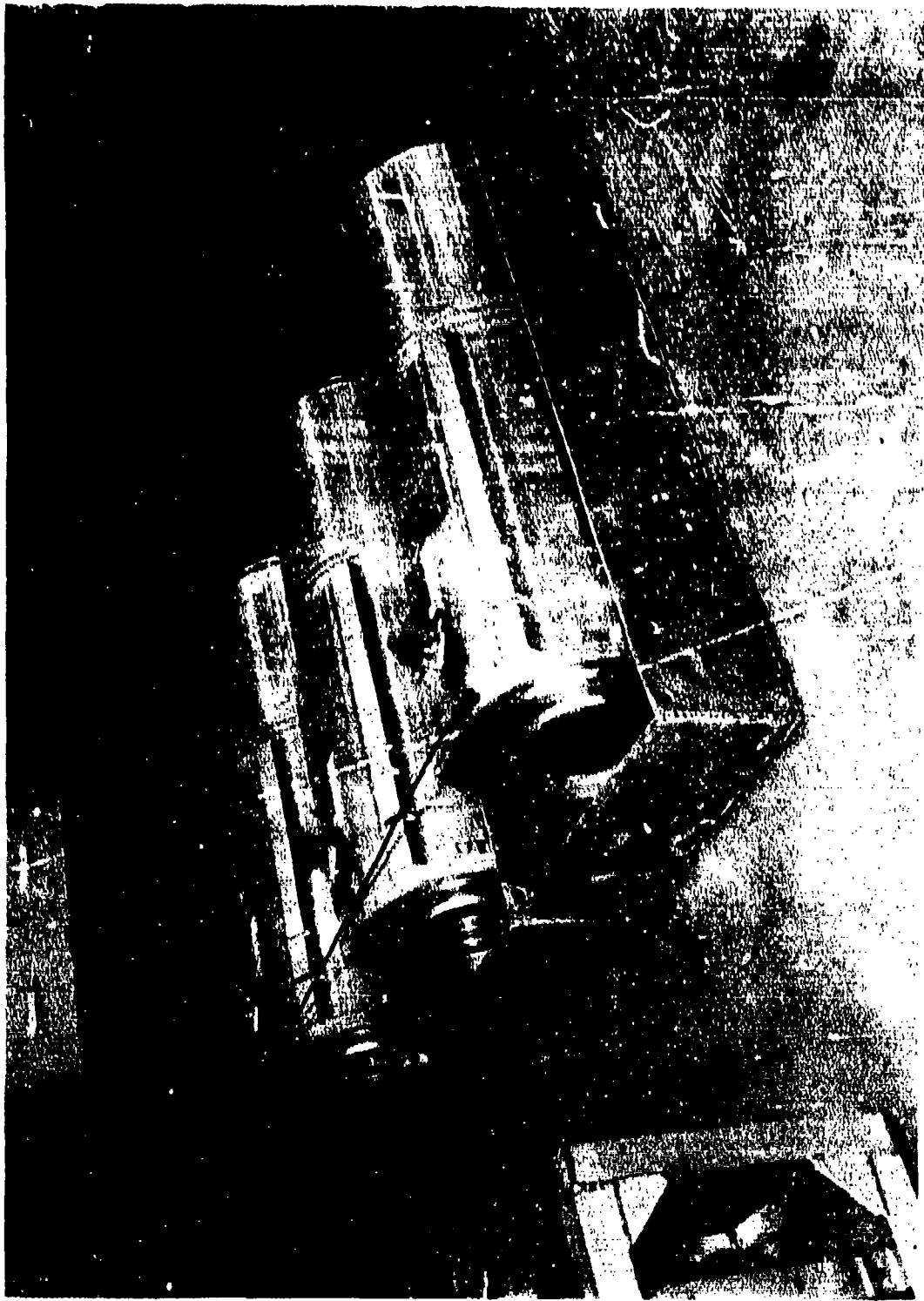

Figure 7. Bullpup Tanks

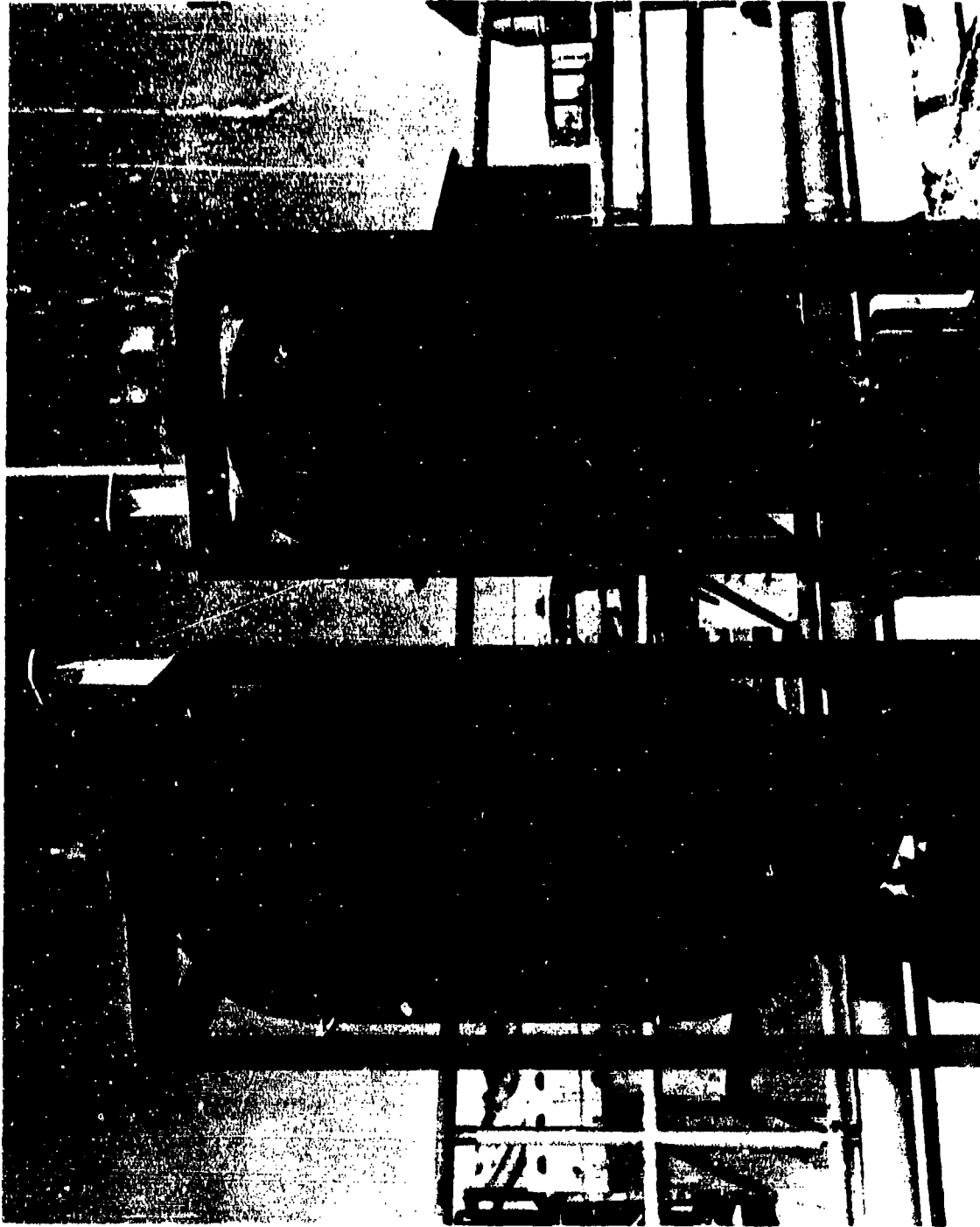

Figure 8. Minimum Cost Design Tanks



Figure 9. ULPR Tanks
34

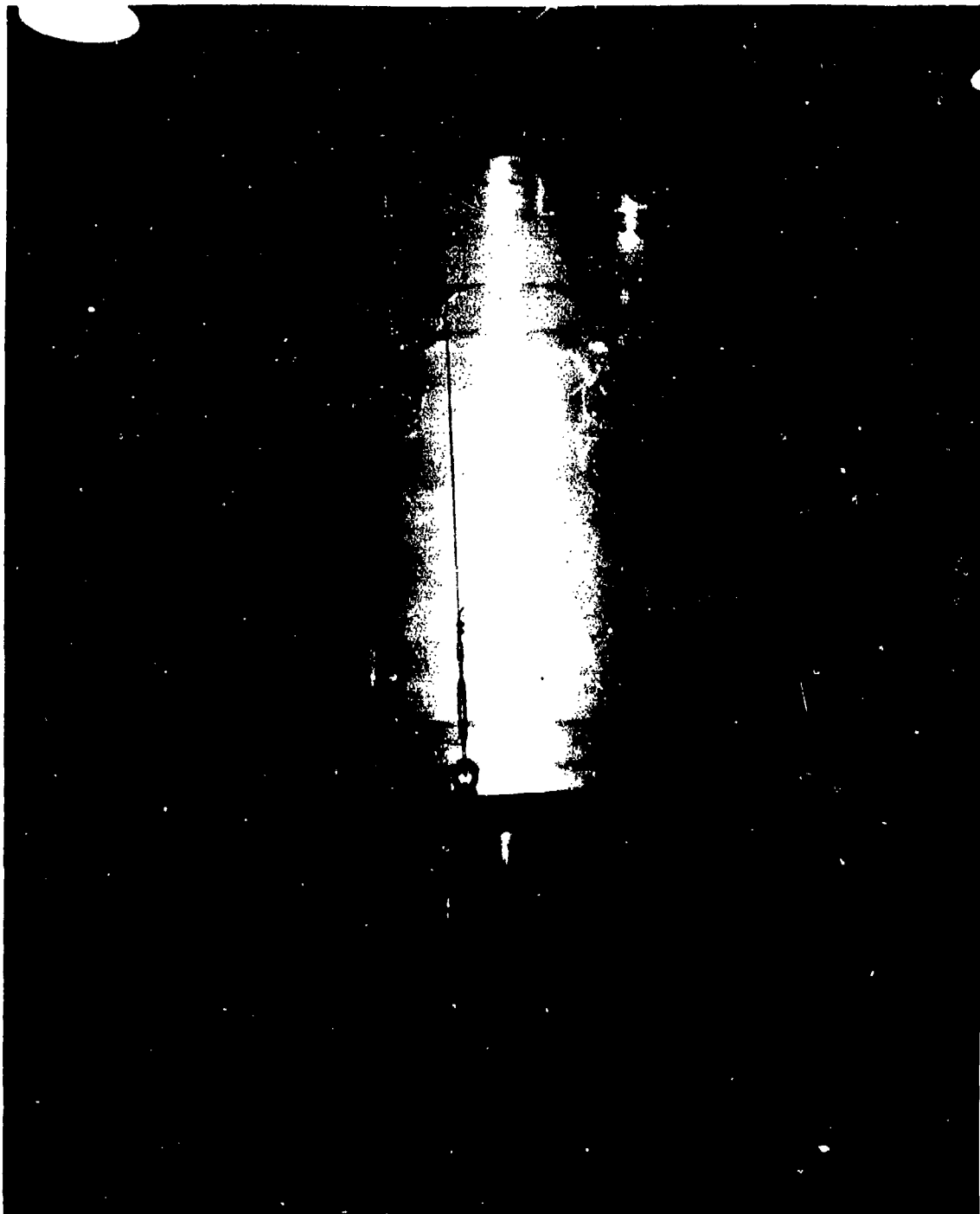

Figure 10. Agena Tank
35



Figure 11. Solid State Bonded Tanks



Figure 12. Twelve-Inch Arc Reversing Diaphragm Tank

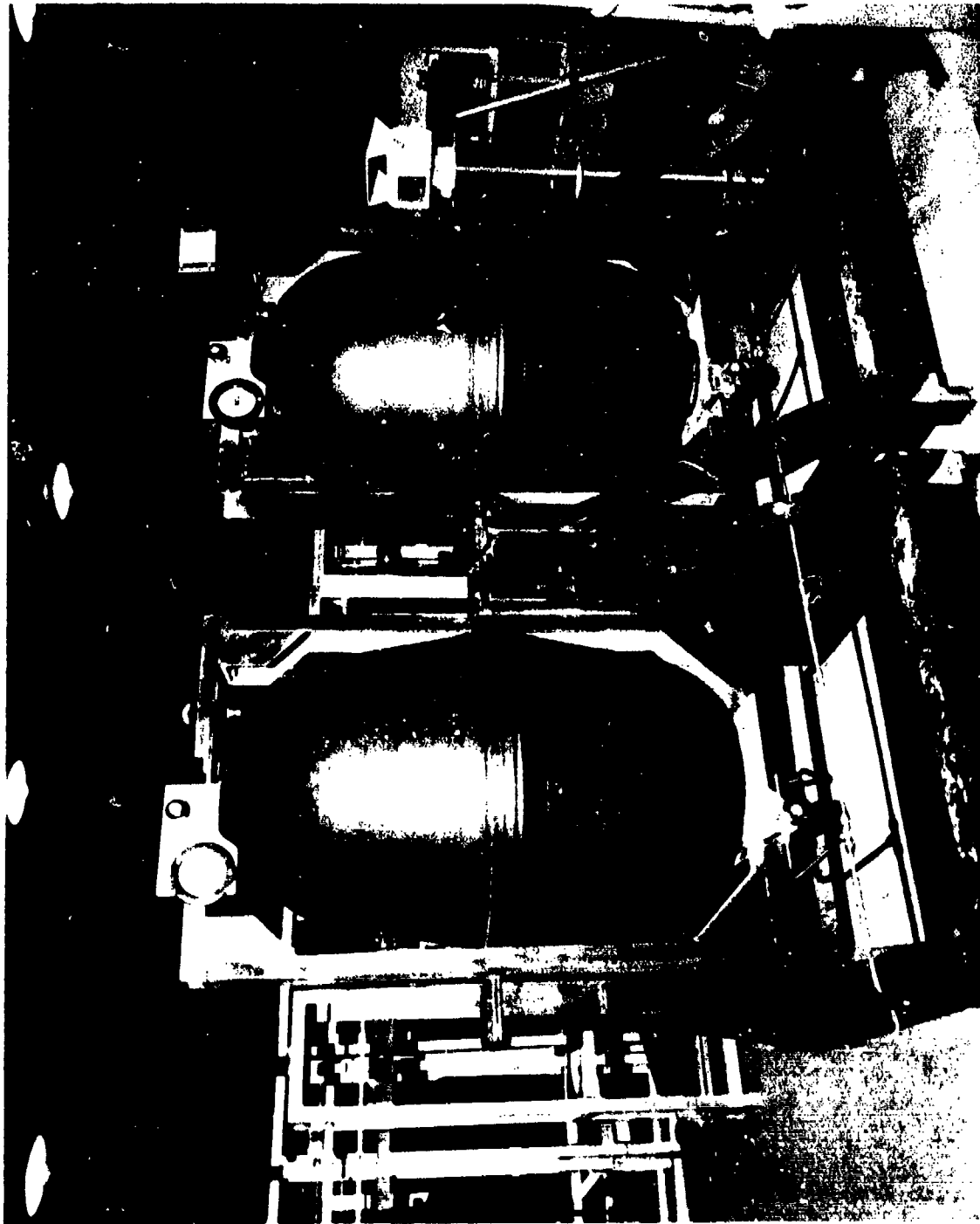

Figure 13. Arde Conospheroid

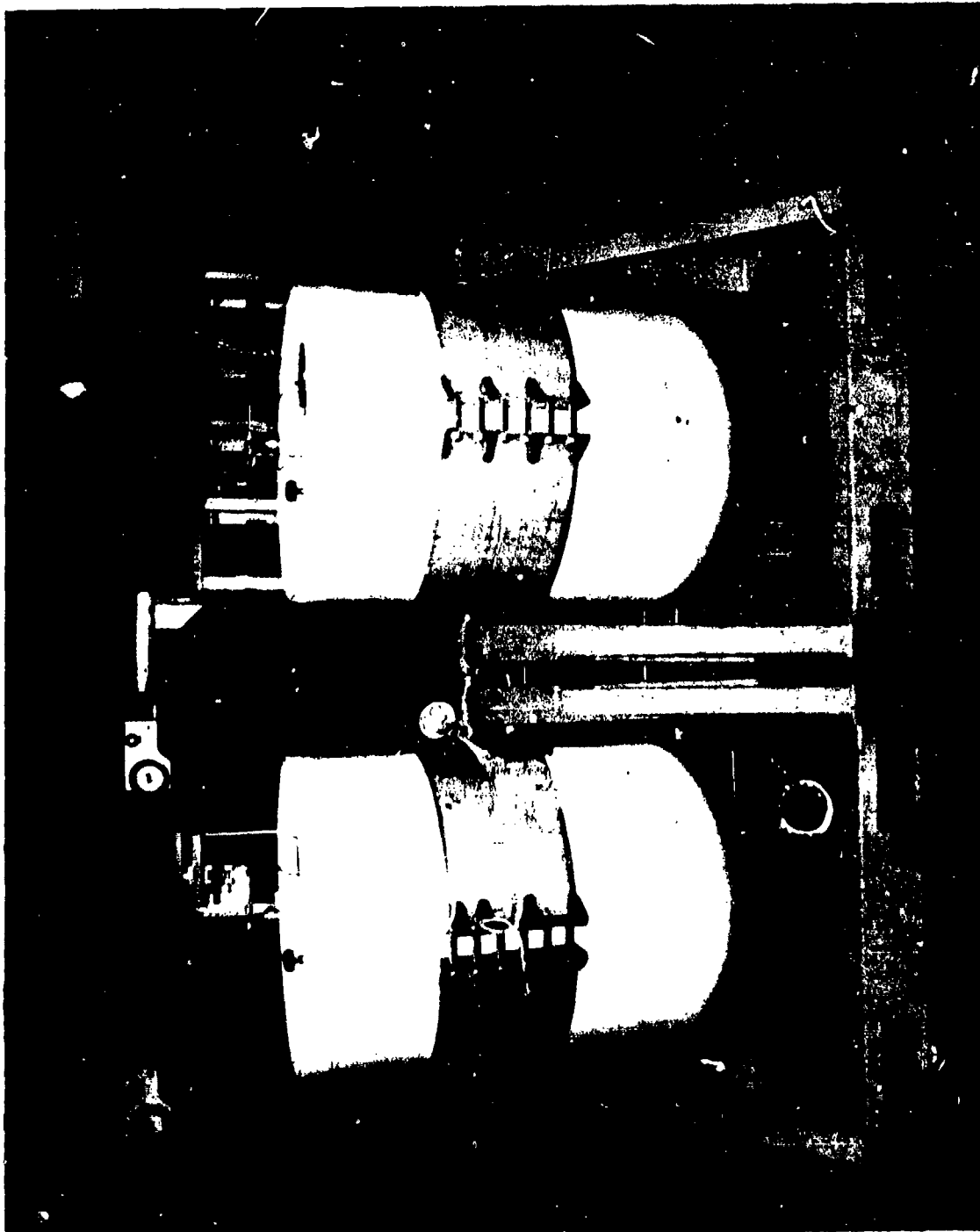

Figure 14. Thiokol Rolling Diaphragm Tanks

<u>PART</u>	<u>MATERIAL</u>
Tank	AM350
Transition Joint	347SST/6061-T6 Al
Pressure Switch	347 SST
Explosive Valve	347 SST
Burst Disk (100 psig)	6061-T651 Al
Burst Disk (120 psig)	6061-T651 Al
Hoke Hand Valve	347 SST
1/2 in. by 0.035 in. Tubing	347 SST
1/2 in. by 0.035 in. Cross	347 SST
1/2 in. by 0.035 in. Tee	347 SST
1/2 in. by 0.065 in. /0.035 in. Tubing	347 SST

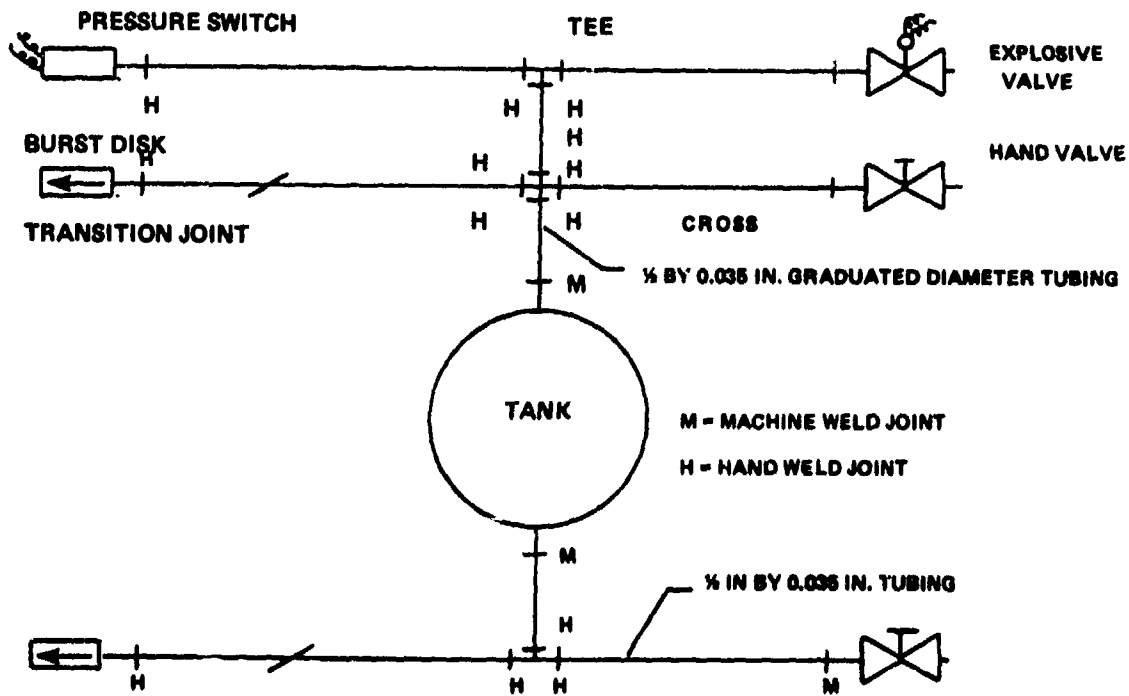

Figure 15. All-Welded Stainless Steel Systems for ClF_5 and N_2O_4 Application

PART

Tank
Transition Joint
Pressure Switch
Explosive Valve
Burst Disk (100 psig)
Burst Disk (120 psig)
Hoke Hand Valve
1/2 in. by 0.035 in. Tubing
1/2 in. by 0.035 in. Cross
1/2 in. by 0.035 in. Tee
1/2 in. by 0.065 in. Tubing

MATERIAL

6061-T6 Al
347 SST/6061-T6 Al
347 SST
6061-T6 Al
6061-T6 Al
6061-T6 Al
347 SST
6061-T6 Al
6061-T6 Al
6061-T6 Al
6061-T6 Al

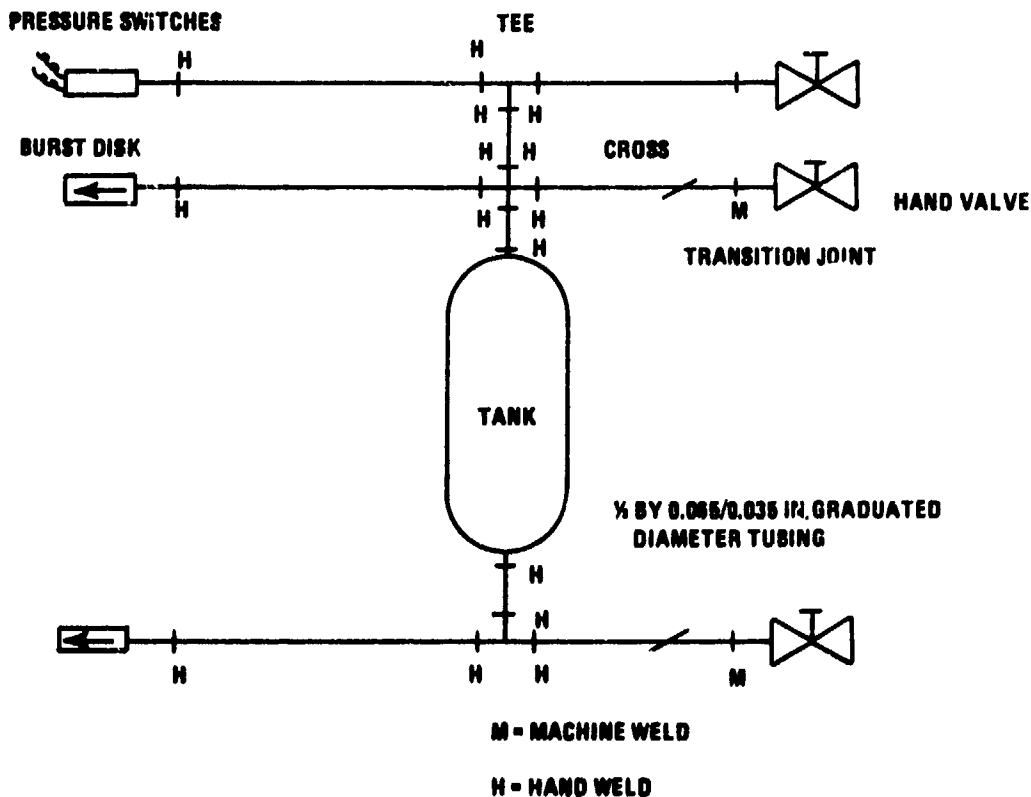

Figure 16. All-Welded Aluminum Systems for ClF_5 and N_2O_4 Application

<u>PART</u>	<u>MATERIAL</u>
Tank	347 SST
Hoke Hand Valve	347 SST
Burst Disk	6061-T6 Al
Transition Joint	347 SST/6061-T6 Al
AFRPL (Connector Elbow (MS27866--8)	347 SST
Bobbin Seal (Unplated)	304-L SST
Plain Flange (MS27853-08)	CRES AMS5646
0.035 Plain Flange (MS27853-08)	CRES AMS5646
Nut (MS27852-08)	A-286
AFRPL Connector Tee (MS27863-08)	AMS4127 Al Alloy
0.065 in. Plain Flange (MS27853-08)	CRES AMS5646
Plain Flange (MS27858-08)	AMS4127 Al Alloy
Bobbin Seal (MS27860-08)	AMS4127 Al Alloy
0.035 in. AFRPL Connector Union (MS27851-08)	

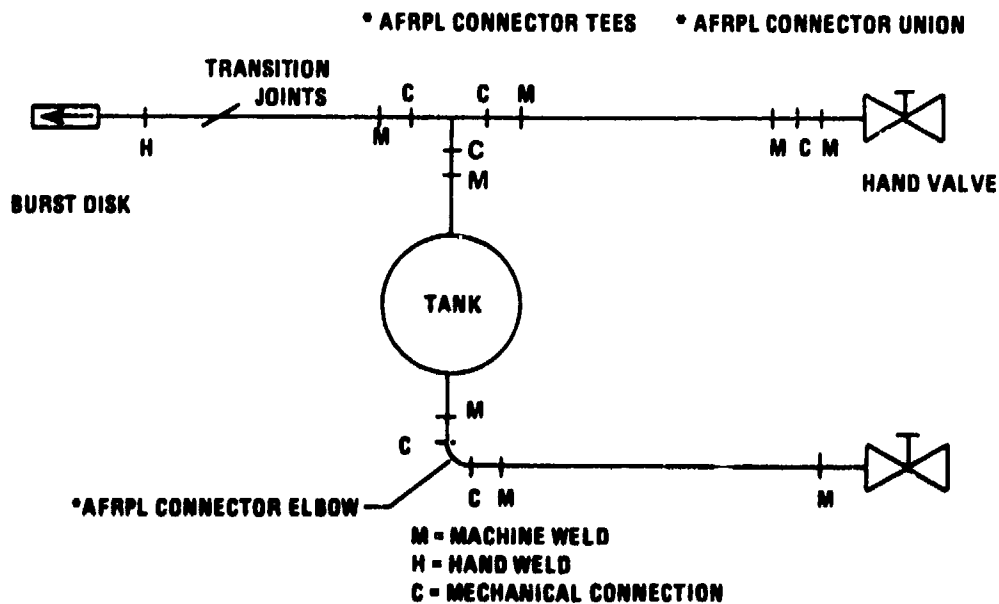

Figure 17. Separable Connector Stainless Steel System for N_2O_4 Application

<u>PART</u>	<u>MATERIAL</u>
Tank	347 SST
Hoke Hand Valve	347 SST
Burst Disk	6061-T6 A1
Transition Joint	347 SST/6061-T6 A1
AFRPL Connector Elbow (MS27866-08)	347 SST
Bobbin Seal (Ni Plated - MS27855-08)	304-L
Plain Flange (MS27853-08)	CRES AMS5646
0.035 Plain Flange (MS27853-08)	CRES AMS5646
Nut (MS27852-08)	A-286
AFRPL Connector Tee (MS27864-08)	AMS4127 A1
0.065 in. Plain Flange (MS27853-08)	CRES AMS5646
Plain Flange (MS27858-08)	AMS4117 A1 Alloy
Bobbin Seal (MS27860-08)	AMS4127 A1 Alloy
0.035 in. AFRPL Connector Union (MS27851-08)	

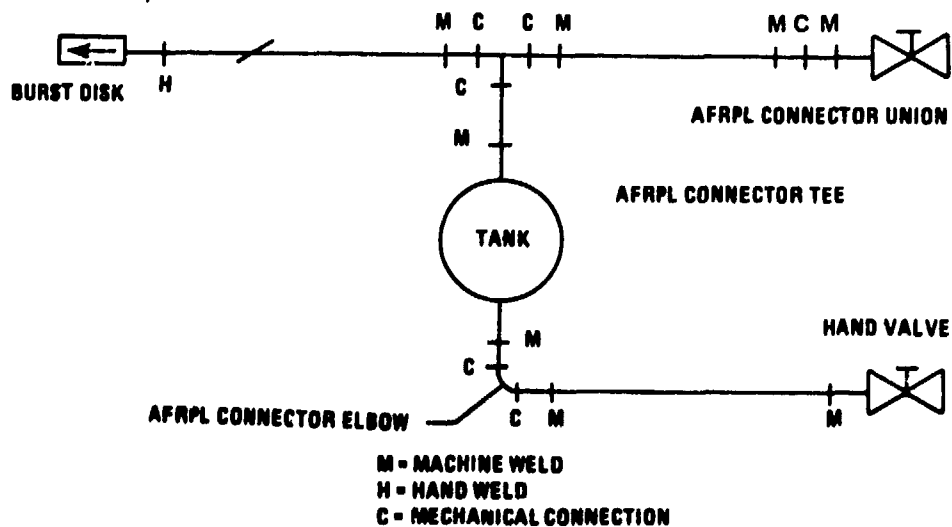

Figure 18. Separable Connector Stainless Steel System for ClF_5 Application

PART	MATERIAL
Tank	2219 Al
Hoke Hand Valve	347 SST
Burst Disk	6061-T6 Al
Transition Joint	347 SST/6061-T6 Al
AFRPL Connector Elbow (MS27862-08)	AMS4127 Al Alloy
Bobbin Seal (MS27860-08)	AMS4127 Al Alloy
Nut (MS27857-08)	AMS4117 Al Alloy
AFRPL Connector Tee (MS27863-08)	AMS4127 Al Alloy
0.065 in. Plain Flange (MS27858-08)	AMS4117 Al Alloy
0.035 in. Plain Flange (MS27858-08)	AMS4117 Al Alloy
0.035 in. AFRPL Connector Union (MS27856-08)	

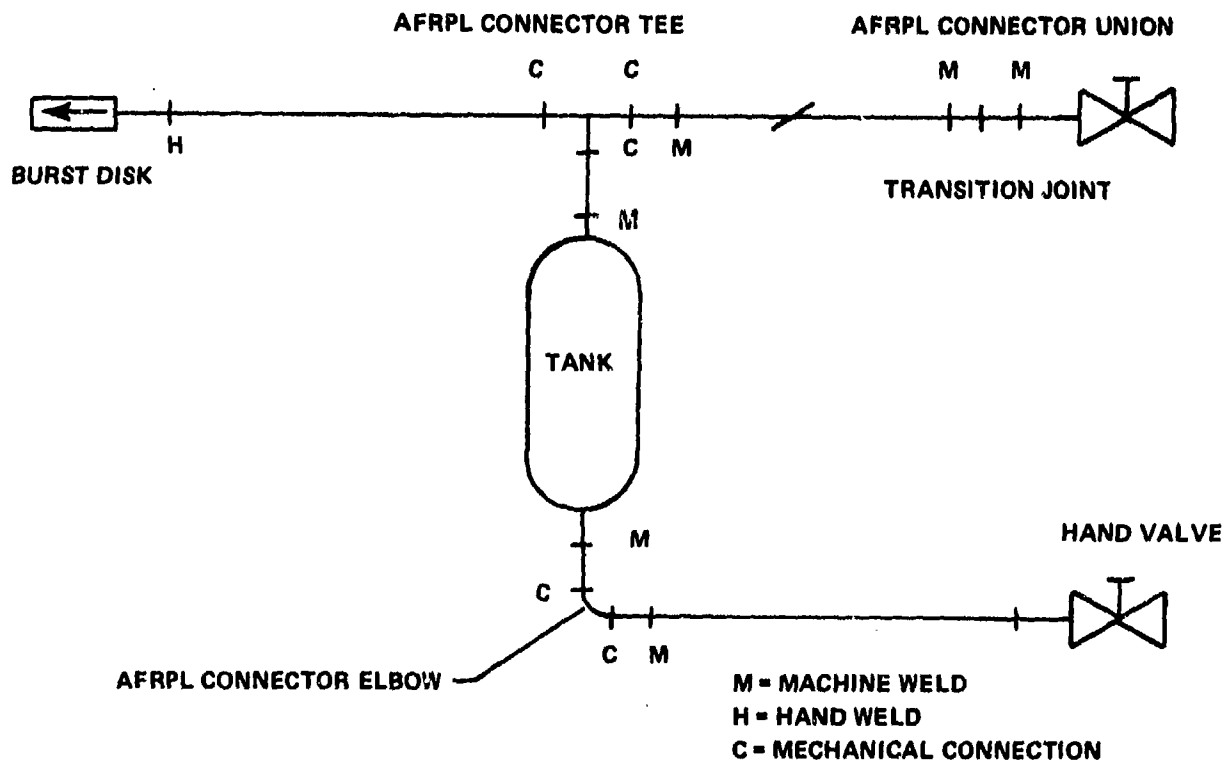

Figure 19. Separable Connector Aluminum Systems for ClF_5 and N_2O_4 Application

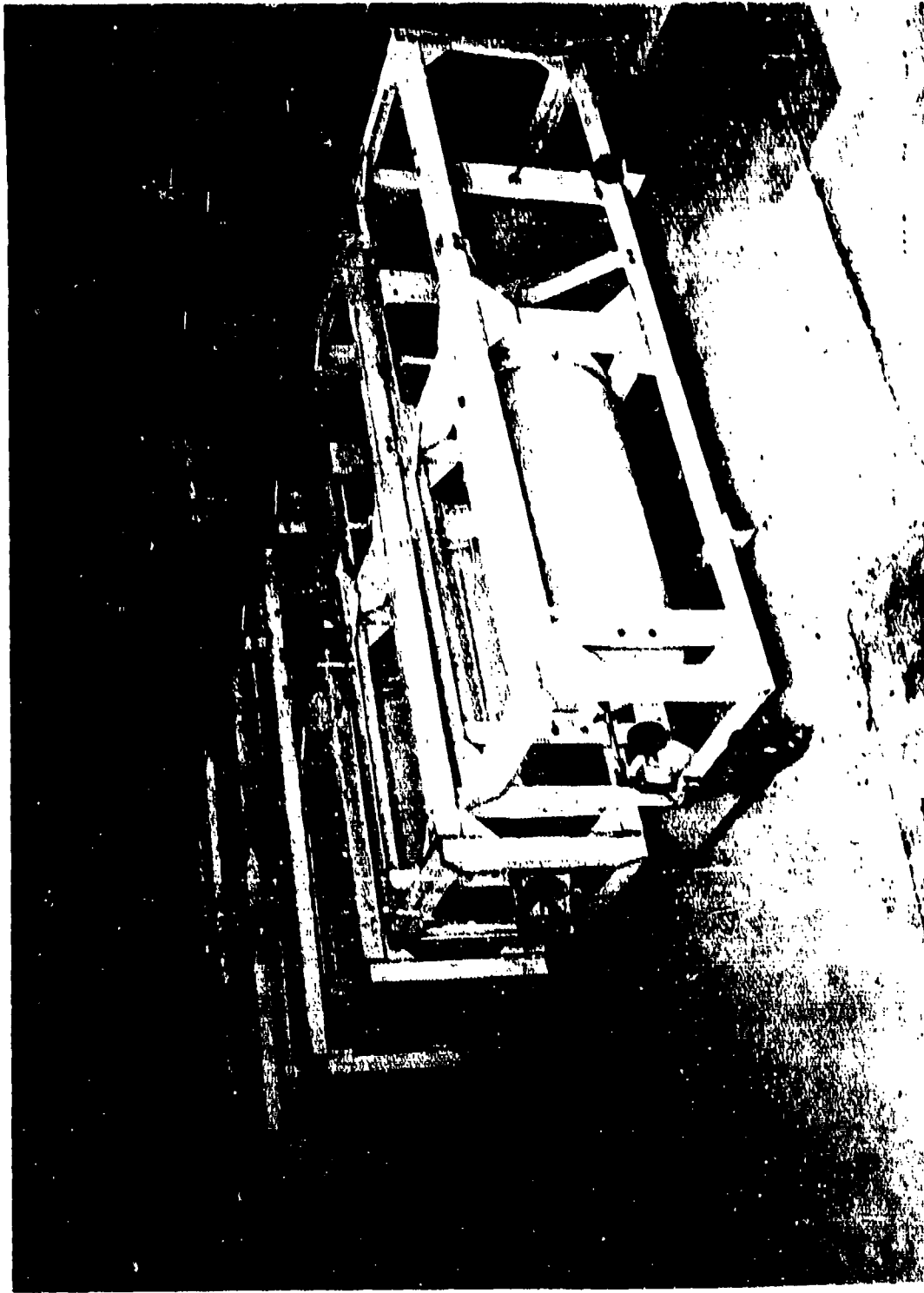

Figure 20. Prepackaged Feed Systems

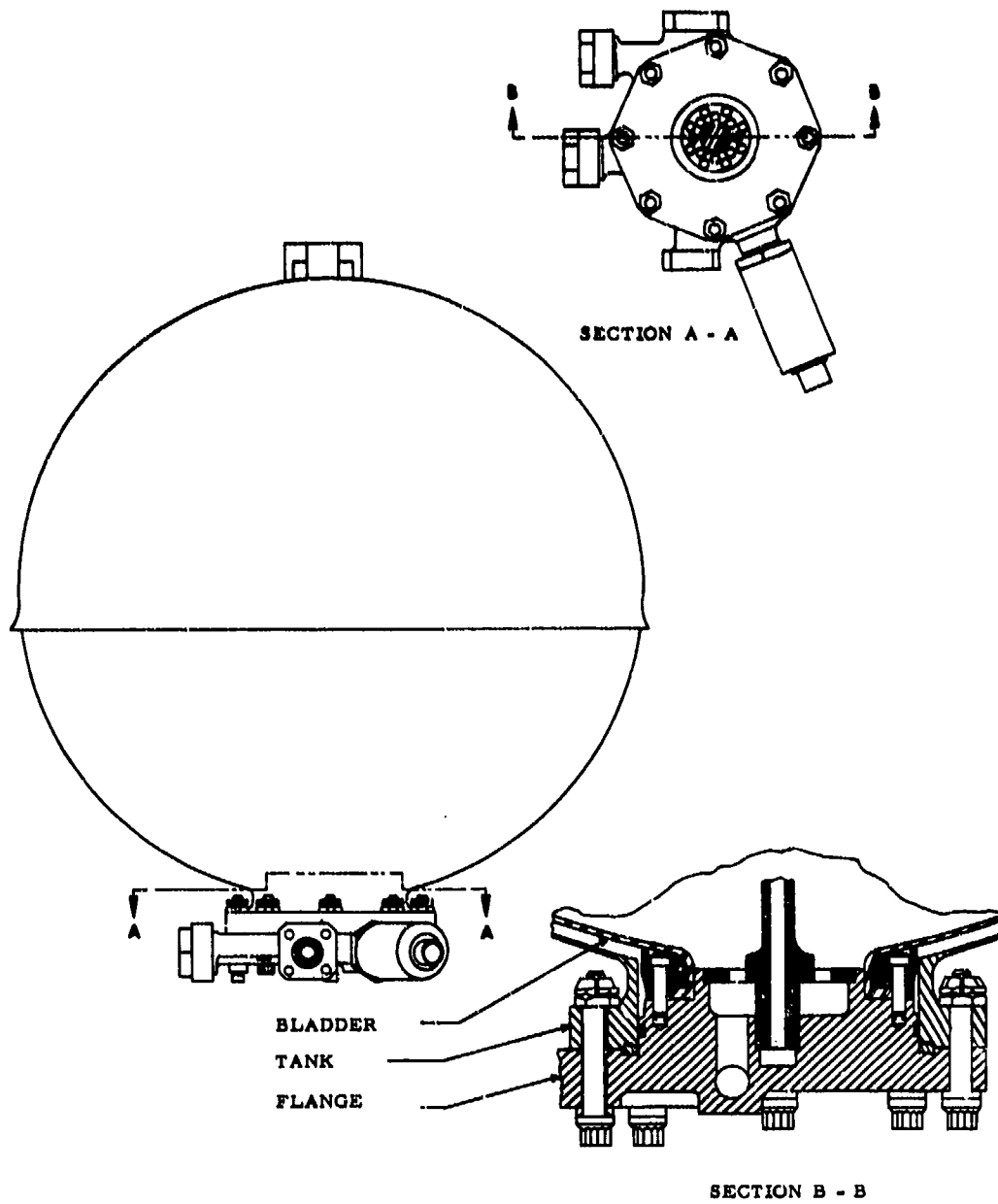

Figure 21. Mariner Tank

TABLE I. GROUP I: SUMMARY OF RESULTS

<u>Propellant</u>	<u>Tank</u>	<u>Quantity</u>	<u>Tank Material</u>	<u>Test Initiated</u>	<u>Test Terminated</u>	<u>Days in Test</u>
N ₂ O ₄ *	3- by 6-inch	4	2014-T6	9-7-66	9-12-66	5
N ₂ O ₄ *	3- by 6-inch	1	2014-T6	1-3-67	1-5-67	2
N ₂ O ₄ *	3- by 6-inch	23	2014-T6	1-3-67	13-5-71	1522
N ₂ O ₄ *	Alcoa 1 quart	6	2014-T6	12-5-66	3-5-71	1548
N ₂ O ₄ *	Alcoa 1 quart	3	6016-T6	12-5-66	3-5-71	1548
N ₂ O ₄ *	Alcoa 1 quart	2	2219-T6	12-5-66	3-5-71	1548
N ₂ O ₄ *	Alcoa 1 quart	1	7007-T6	12-5-66	3-5-71	1548
N ₂ O ₄ *	Alcoa 1 quart	2	2021-T6	12-5-66	3-5-71	1548
N ₂ O ₄ *	Alcoa 1 quart	2	5456-T6	12-5-66	3-5-71	1548
N ₂ O ₄ *	Arde 1 pint	5	AISI 301	6-21-67	7-20-72	1856
	Cryo Form		aged			
N ₂ O ₄ *	Arde 1 pint	5	AISI 301	6-21-67	7-20-72	1856
	Cryo Form		unaged			
ClF ₅	Alcoa 1 quart	1	6061-T6	9-7-66	7-16-68	973
ClF ₅	Alcoa 1 quart	1	6061-T6	9-7-66	5-14-69	616
ClF ₅	Alcoa 1 quart	1	6061-T6	9-7-66	1-17-69	524
ClF ₅	Alcoa 1 quart	3	6061-T6	4-7-66	8-3-72	2310
ClF ₅	Alcoa 1 quart	8	2014-T6	9-7-66	8-3-72	2157
ClF ₅	Alcoa 1 quart	4	2014-T6	9-7-66	2-27-70	655
ClF ₅	Alcoa 1 quart	1	2014-T6	9-7-66	5-22-67	57
ClF ₅	Alcoa 1 quart	4	2219-T6	4-7-66	8-3-72	2310
ClF ₅	Alcoa 1 quart	4	2021-T6	9-7-66	8-3-72	2157
ClF ₅	Alcoa 1 quart	3	3003-T6	9-7-66	8-3-72	2157
ClF ₅	Alcoa 1 quart	3	5456-T6	9-7-66	8-3-72	2157

* MIL-P-26539 Specification N₂O₄

TABLE I. GROUP I: SUMMARY OF RESULTS (Cont'd)

<u>Propellant</u>	<u>Tank</u>	<u>Quantity</u>	<u>Tank Material</u>	<u>Test Initiated</u>	<u>Test Terminated</u>	<u>Days in Test</u>
ClF ₅	Alcoa 1 quart	1	5456-T6	9-7-66	2-27-70	655
ClF ₅	Alcoa 1 quart	1	7007-T6	9-7-66	8-3-72	2157
ClF ₅	Alcoa 1 quart	1	7007-T6	9-7-66	8-11-69	635
ClF ₅	Arde 1 pint	1	AISI 301 aged	8-25-67	9-14-69	751
ClF ₅	Cryo Form					
ClF ₅	Arde 1 pint	4	AISI 301	8-23-67	7-20-72	1793
ClF ₅	Cryo Form		aged			
ClF ₅	Arde 1 pint	5	AISI 301	8-23-67	7-20-72	1793
ClF ₅	Cryo Form		unaged			
N ₂ H ₄	Arde 1 pint	15	AISI 301	10-26-71	} No excessive pressure rise	
N ₂ H ₄	Cryo Form		aged			
N ₂ H ₄	Arde 1 pint	14	AISI 301	10-26-71	} No excessive pressure rise	
N ₂ H ₄	Cryo Form		unaged			

TABLE II. GROUP II: SUMMARY OF RESULTS

<u>Propellant</u>	<u>Tank</u>	<u>Quantity</u>	<u>Tank Material</u>	<u>Test Initiated</u>	<u>Test Terminated</u>	<u>Days in Test</u>
N ₂ O ₄ *	Martin	1	2014-T6	1-3-67	1-25-67	22
N ₂ O ₄ *	Martin	1	2014-T6	1-3-67	9-8-72	2075
N ₂ O ₄ *	GD/C	2	2014-T6	1-3-67	9-8-72	2075
N ₂ O ₄ *	Martin	1	6A1-4V	1-3-67	1-13-67	10
N ₂ O ₄ *	Martin	1	6A1-4V	1-3-67	2-7-67	34
N ₂ O ₄ *	Martin	1	6A1-4V	1-3-67	2-8-67	35
N ₂ O ₄ *	GD/C	1	5A1-2.5Sn	1-3-67	1-17-67	14
N ₂ O ₄ *	GD/C	1	5A1-2.5Sn	1-3-67	1-19-67	16
N ₂ O ₄ *	GD/C	2	6061-T6	1-3-67	9-8-72	2075
N ₂ O ₄ *	Martin	1	7039-T6	1-3-67	7-11-68	555
N ₂ O ₄ *	Martin	1	7039-T6	1-3-67	9-8-72	2075
N ₂ O ₄ *	GD/C	1	AM350	1-3-67	10-24-67	294
N ₂ O ₄ *	Martin	1	17-7PH	1-3-67	10-25-67	295
N ₂ O ₄ *	GD/C	3	2021-T6	8-4-69		In test
N ₂ O ₄ **	GD/C	3	6A1-4V	8-4-69		In test
CIF ₅	Martin	1	2014-T6	1-3-67	3-6-67	58
CIF ₅	GD/C	1	2014-T6	1-3-67	9-12-72	2079
CIF ₅	GD/C	1	AM350	1-3-67	10-24-67	294
CIF ₅	GD/C	1	AM350	1-3-67	10-25-67	295
CIF ₅	GD/C	1	6061-T6	1-3-67	9-12-72	2079
CIF ₅	Martin	1	7039-T6	11-28-68	12-29-70	460
CIF ₅	Martin	1	17-7PH	1-3-67	3-9-67	64
CIF ₅	Martin	1	17-7PH	1-3-67	10-23-67	293

* MIL-P-26539 Specification N₂O₄

** MSC-PPC-2A Specification N₂O₄

TABLE II. GROUP II: SUMMARY OF RESULTS (Cont'd)

<u>Propellant</u>	<u>Tank</u>	<u>Quantity</u>	<u>Tank Material</u>	<u>Test Initiated</u>	<u>Test Terminated</u>	<u>Days in Test</u>
$N_2O_4^{**}$	Bullpup	3	2014-T6	6-10-68		In test
$N_2O_4^{**}$	ULPR	2	2219-T81	5-21-68	2-25-71	1011
N_2H_4	Martin	5	17-7PH	11-9-71	} No excessive pressure rise	}
N_2H_4	Martin	5	AM350	11-9-71		
N_2H_4	Martin	5	A286	11-9-71	} No excessive pressure rise	}
N_2H_4	Martin	5	2021-T6	11-9-71		
N_2H_4	Martin	5	2014-T6	11-9-71	} No excessive pressure rise	}
N_2H_4	Martin	5	2219-T8	11-9-71		
N_2H_4	Martin	5	6A1-4V	11-9-71	} No excessive pressure rise	}
N_2H_4	GD/C	3	6A1-4V	11-9-71		
N_2H_4	GD/C	3	2021-T6	11-9-71		

TABLE II. GROUP II: SUMMARY OF RESULTS (Cont'd)

Propellant	Tank	Quantity	Tank Material	Test Initiated	Test Terminated	Days In Test	Remarks
CIF ₅	Martin	5	2021-T6	3-1-72			AFRPL Connector Leakage
CIF ₅	Martin	5	7039-T6	3-1-72			
CIF ₅	Martin	4	A286	3-1-72			
CIF ₅	Martin	4	Inconel 718	3-1-72			
N ₂ O ₄	Martin	6	2219-T8	3-1-72			
N ₂ O ₄	GD/C	6	17-7-PH	3-1-72			
CIF ₅	Martin	6	2219-T8	3-1-72			
CIF ₅	GD/C	5	17-7PH	3-1-72			

TABLE IIIA. GROUP III: SUMMARY OF RESULTS

<u>Propellant</u>	<u>Number</u>	<u>Pressure System</u>	<u>Expulsion System</u>	<u>Test Initiated</u>	<u>Test Terminated</u>	<u>Days in Test</u>
MHF-5	2	LGG	RD	6-9-67		In test
MHF-5	2	SGG	RD	6-9-67		In test
MHF-5	1	H	RD	6-9-67		In test
MHF-5	2	LGG	ST	6-9-67		In test
MHF-5	2	SGG	ST	6-9-67		In test
MHF-5	2	H	ST	6-9-67		In test
N ₂ O ₄	2	LGG	RD	5-22-67	3-24-71	1402
N ₂ O ₄	2	SGG	RD	5-22-67		In test
N ₂ O ₄	2	H	ST	5-22-67	12-4-70	1292
ClF ₅	1	SGG	RD	6-20-67	10-7-67	20
ClF ₅	1	H	ST	8-4-67	10-23-67	80
ClF ₅	1	H	ST	8-4-67	8-18-70	1110
N ₂ O ₄ *	1	LGG	RD	5-10-67	12-20-70	941
N ₂ O ₄ *	1	LGG	RD	5-10-67	12-4-70	1304
N ₂ O ₄ *	1	SGG	RD	5-10-67		In test
N ₂ O ₄ *	1	H	RD	5-10-67	2-3-71	1367

* MSC-PPC-2A Specification N₂O₄

NOTE: LGC = liquid gas generator; SGG = solid gas generator; H = stored helium; ST = surface tension; RD = rolling diaphragm.

TABLE IIIB. GROUP III: SUMMARY OF RESULTS

<u>Propellant</u>	<u>Tank</u>	<u>Quantity</u>	<u>Expulsion Device</u>	<u>Material</u>	<u>Test Initiated</u>	<u>Test Terminated</u>	<u>Days in Test</u>
N ₂ O ₄ *	Arde	2	Ring-stiffened diaphragm	AISI 301 Cryo Form	7-3-69		In test
N ₂ O ₄ *	Arde	2	Ring-stiffened diaphragm (conospheroid)	AISI 301 Cryo Form	12-23-70		In test
N ₂ O ₄ *	Thiokol	2	Rolling diaphragm	Shell-200 Maraging Diaphragm-1100-0	1-5-71		In test
N ₂ O ₄ *	Thiokol	1	Rolling diaphragm	Shell-200 Maraging Diaphragm-1100-0	1-5-71	3-15-71	In test
ClF ₅	Arde	2	Ring-stiffened diaphragm	AISI 301 Cryo Form	7-3-69		In test
N ₂ H ₄	Arde	2	Ring-stiffened diaphragm	AISI Cryo Form	11-9-71		In test
N ₂ H ₄	Mariner	3	AF-E-332 Bladder	Elastomeric	5-18-72		In test

* MSC-PPC-2A Specification N₂O₄

REFERENCES

1. C. Fateno, et al, Improved Leak Detection Correlation of Actual Leakage with Instrumentation Indications, Effect of Humidity on Leaks and Categorization of Leak Information, CR-46-14S, Final Report DSRS 10411, Contract AF041(347)-576, Martin Company, 16 June 1964.
2. J. E. Branigan, Long-Term Storability of Propellant Tankage and Components, AFRPL-TR-69-82, Air Force Rocket Propulsion Laboratory, April 1969.
3. R. B. Mears, 1st Lt, USAF, Long-Term Storability of Propellant Tankage and Components, Interim Report No. 2, AFRPL-TR-70-43, Air Force Rocket Propulsion Laboratory, May 1970.
4. H. M. White, 2nd Lt, USAF, Long-Term Storability of Propellant Tankage, AFRPL-TR-71-20, Air Force Rocket Propulsion Laboratory, March 1971.
5. H. M. White, 1st Lt, USAF, Long-Term Storability of Propellant Tankage, AFRPL-TR-71-113, Air Force Rocket Propulsion Laboratory, November 1971.

AUTHOR'S BIOGRAPHY

HOWARD M. WHITE, CAPT, USAF

Capt White was born in Philadelphia, Pennsylvania, in 1947. He attended Lehigh University in Bethlehem, where he was graduated in 1969 with honors in Chemical Engineering.

Prior to entering the Air Force he was employed as a process design engineer by Betz Laboratories in Trevose, Pennsylvania.

Capt White is currently serving as a project engineer in the Liquid Rocket Division at the Air Force Rocket Propulsion Laboratory. He is responsible for the areas of propellant/material compatibility, liquid rocket tankage and pressurization.

APPENDIX A

REPORT ON LEAK IN ALUMINUM TANK
PROJECT 305805 FRJ REPORT NO. 87

LABORATORY TEST REPORT		Report Nr. 87	Date 29 Sep 71
Requesting Organization (Symbol and/or Name) AFRPL (TSCB)		Name of Requestor Mr. C. Hurd	Phone Number 32354
Sample, Test or Project 305805 FRJ Package System Storability			
Work Required Determine Cause of Leak in Aluminum Alloy Tank			
TEST DATA			
I. <u>MATERIAL</u> : 6061-T6 Al alloy Alcoa 1-qt. tank with 4043 Al alloy weldment filler.			
II. <u>BACKGROUND</u> : Tank (S/N 16) exhibited leakage and a large accumulation of corrosion products at a lug-to-tank weldment (Figs. 1 & 2) during storage testing in an environment of 85°F and 85% relative humidity. The tank successively contained two fluids: ClF ₃ for 2 years, followed by ClF ₅ for 6 1/2 months. External "Cracks" (Fig. 3) were also noted in the lug-to-tanks weldments after storing ClF ₅ .			
III. <u>CONCLUSIONS</u> : The ClF ₅ corrosively attacked the interior of the tank to produce intergranularly corroded passages (resembling cracks) from an interior surface "seam" on a lug-to-tank weldment. The ClF ₅ leakage into the warm, humid environment subsequently corroded the exterior of the tank, to cause the corrosion products to accumulate near the leak.			
IV. <u>OBSERVATIONS & DISCUSSION</u> :			
A. Surface Observations:			
1. The leak pattern as revealed in Figs. 1 & 2 indicated that the ClF ₅ reacted aggressively with the container when admitted to the external environment. Outside general surface corrosion of the tank (near the leak) was 0.015-0.020 in. deep.			
2. The up-lifted features of the corroded weld bead (Fig 3) gave proof of expansion forces set up by the corrosion products in the corroded passages.			
3. The lug-to-tank weldment surface facing the tank interior had a peculiar "seam" near the crown of the weld (Fig 4). The "seam" appeared to be the result of a slight shift of the lug or tank before the weld bead solidified. This "seam" apparently behaved as a corrosion crevice, where the leak did in fact have its origin.			
4. The inside wall of the tank exhibited tiny, corrosion pits, which penetrated from the inside, to a depth of at least 0.017 in. This occurrence was evidence toward corrosive attack from within the tank.			
It is certified that this is an accurate report of test or analysis performed by the Chemical & Materials Branch.			
Performed By		Signature of Approving Official	
Name G. S. Whiting, Sgt.	Name	Name John I. Nakamura	
Name	Name	Title Chief	Section Analytical
		Chemical & Materials Branch	

5. The stop-pass weld had no crack across it, except for one coming into it partway from the nearby leak region. Different from other tank failure analyses in which the stop-pass weld was a particular interest, the "seam" on the other side of the weld was a particular interest in this analysis.

B. Metallurgical Observations:

1. Small voids or gas-bubble pockets were scattered through the weld, and along a corrosion passage. Such voids assist propagation of a corrosion network.

2. The weld interdendritic material had a good pearlitic-type microstructure, i. e., no coring. Coring of the weld has been a microstructural problem with other tanks.

3. Deposits of copper were found in corrosion passages penetrating from the exterior side of the weld (Figs 5 and 6). As a galvanic couple, aluminum is prone to corrode and copper to plate. The observed copper may have plated from the alloy metal dissolved by the corroding species. An explanation for the origin and deposition of this copper is confused by the low copper content in 6061 and 4043 aluminum alloys: 0.15 to 0.4 percent for 6061; 0.3 percent for 4043. It must be noted, however, that the copper was present at the tips of the corrosion passages. There (with the presence of moisture) the aluminum would preferentially corrode and thereby advance the corrosion passages.

C. Corrosion Products:

1. X-ray fluorescence analysis of the corrosion products (Figs 1 and 2) detected those elements with atomic numbers between 13 (Al) and 30 (Zn). The dominant elements in the corrosion products were aluminum, chlorine, and copper.

2. Specific ion analysis of the same material determined the amount of water soluble chlorides and fluorides. The results were 2.8 percent fluorides and 0.3 percent chlorides.

3. X-ray diffraction analysis revealed that most of the sample was amorphous, though two crystalline compounds were identified: a hydrated aluminum fluoride and a hydrated copper chloride, of which only the latter is soluble in water.

4. These data merely indicated that the corrosive species were fluoride and chloride ions, which is in accord with the conclusions.



Figure A-1. Corrosion Products on Tank

A-3

Reproduced from
best available copy.

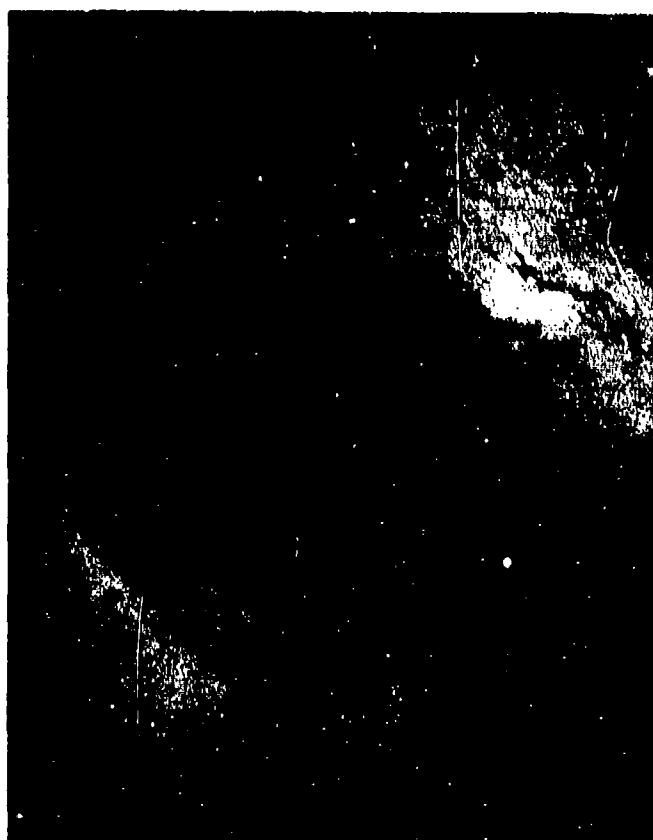

Figure A-2. Corrosion Products Near Tank

A-4



Figure A-3. Leak Passage in Lug-to-Tank Weld

A-5



**Figure A-4. Circumferential "Seam" on Interior
Side of the Leak**

63

A-6



**Figure A-5. Penetration of Corrosion
Into Weld From Outside**

A-7



Figure A-6. Copper Deposited at Tip
of Corroded Passage

A-8

APPENDIX F

ALUMINUM ALLOY TANK FAILURE ANALYSIS

PROJECT 305805 FRJ REPORT NO. 295

LABORATORY TEST REPORT		Report Nr. 295	Date 17 Dec 71
Requesting Organization (Symbol and/or Name) AFRPL/TSCB		Name of Requestor Mr. D. Kline	Phone Number 32354
Sample, Test or Project 305805FRJ Packaged System Storability			
Work Required Aluminum Alloy Tank Failure Analysis			
TEST DATA			
<p>I. <u>Material</u>: M826-T6 Al alloy - (presently known as X7007-T6 Al alloy)</p> <p>II. <u>Background</u>: Tank (S/N C-1) exhibited leakage with accumulation of corrosion products on girth weld (Fig. 1). The tank successively contained two fluids during storage testing in an environment of 85°F and 85% humidity: ClF₃ for 2 years, followed by ClF₅ for 2 years, 9 months.</p> <p>III. <u>Conclusions</u>: The leak resulted from external corrosion in a storage environment containing halide (chloride and fluoride) ions. Pitting corrosion and exfoliation in the heat affected zone (HAZ) of the girth weld eventually gave rise to a stress corrosion crack, which permitted the ClF₅ to leak from the tank.</p> <p>IV. <u>Observations and Discussion</u>:</p> <div style="text-align: right; border: 1px solid black; padding: 2px; display: inline-block;"> Reproduced from best available copy. </div> <p>1. <u>Alloy Identification</u>. The M826 is an experimental alloy designation. X-ray fluorescence and information from Mr. Anderson of Alcoa (Los Angeles) identified the material as X7007 aluminum alloy.</p> <p>2. <u>Exterior Appearance</u>: The only evidence of chemical attack or leakage was at the one location on the girth weld (Fig. 1, 2,). The corrosion occurred in the HAZ (heat affected zone). Elsewhere, the welds appeared in excellent condition when examined at 20X.</p> <p>3. <u>Interior Appearance</u>: No corrosion effects were observed, except for ten tiny etch pits at one end of the crossover weld, which lies perpendicular over the girth weld. These pits, located in the HAZ, had not penetrated through the tank wall.</p> <p>4. <u>Microscopic Observation About the Leak</u>: The leak region of the tank was examined up to 200X. The interior surface revealed two cracks in the vicinity of the leak. (Fig. 3, 4, 5). One of these cracks was parallel and one perpendicular (about 0.03 in. long) to the girth weld. The "parallel" crack (Fig. 3) was located amid porosity in the weld filler near the edge of the crown. The "perpendicular"</p>			
It is certified that this is an accurate report of test or analysis performed by the Chemical & Materials Branch.			
Performed By		Signature of Approving Official	
Name Sgt. S. WHITING	Name	Name <i>John L. Nakamura</i>	
Name	Name	Title Chief	Section Analytical Section
Chemical & Materials Branch			

crack occurred in the HAZ from the porous region of the weld out into the base material. The local pitting on the exterior disguised the presence of any cracks in the leak region.

5. Metallurgical Observations: The leak region of the tank was sectioned (Fig. 2), mounted, polished, and examined up to 200X. The "perpendicular" crack became the one of particular interest since it penetrated the base material. Successive cross-sections and polishing revealed the structure and growth of this crack. (Fig. 6, 7, 8, 9). As noted in Figure 8, two branches (like leaves) of the same crack progressed to the interior surface of the tank.

The crack network was initiated after local pitting and exfoliation corrosion had occurred on the exterior surface due to the presence of fluoride and chloride ions in the storage environment. The exfoliation was exemplified in Figures 7 and 9 in the upper right, and was also apparent as part of the action in the lower left. After certain corrosion penetration, intergranular cracking proceeded through the remaining wall thickness with directional growth characteristic of stress corrosion cracking. Two branches of this crack appeared on the interior side. Thus, ClF₅ contained in the tank leaked to the outside through the passageways of this crack.

6. Reference AFRPL/RPCC Lab Report No. 936, dtd 20 Oct 1969. The tank cited in this failure analysis report was of 7007 Al alloy. Its storage lifetime while containing ClF₅ was about one-sixth that of the tank being reported. The cause of the failure was basically the same: para III, "The tank failed as a result of environmentally induced stress corrosion cracking. The primary leak occurred at the cross-over weld bead."



Figure B-1. Corrosion Products on Girth Weld

B-3

Reproduced from
best available copy.

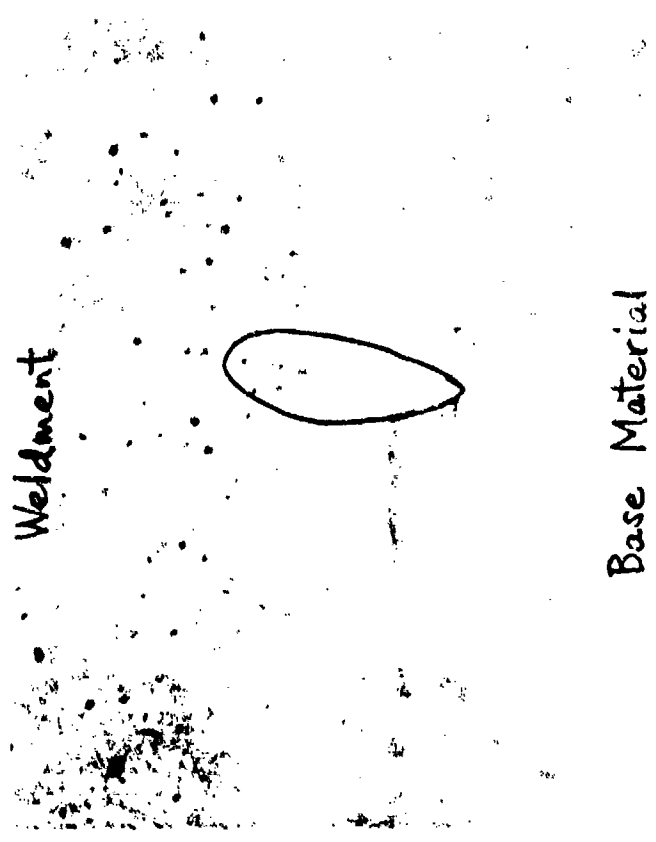

**Figure B-2. Same Location as Figure 1, With
Corrosion Products Removed and the Region
Sectioned. Arrows at Cross-Section
That was Examined**



**Figure B-3. Crack in HAZ;
Parallel to Girth Weld**

B-5



**Figure B-4. Crack Emanating from HAZ;
Perpendicular to Girth Weld**

B-6

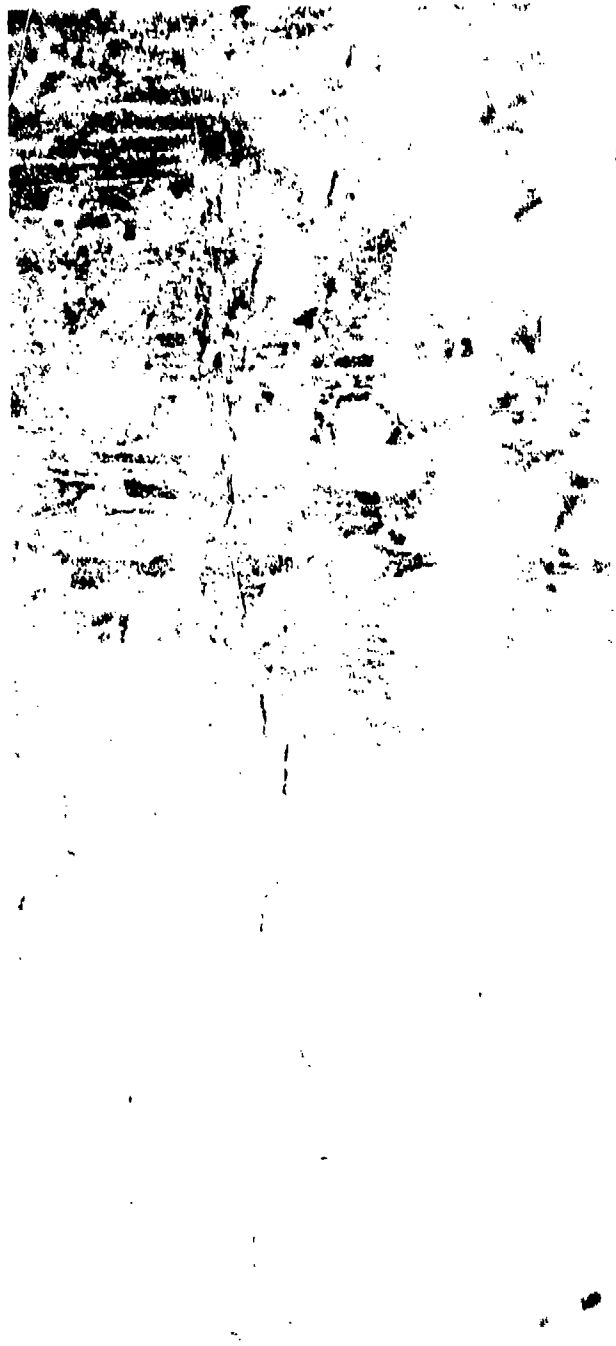

Figure B-5. Same as Figure B-4;
Weldment at Bottom of Photo

B-7

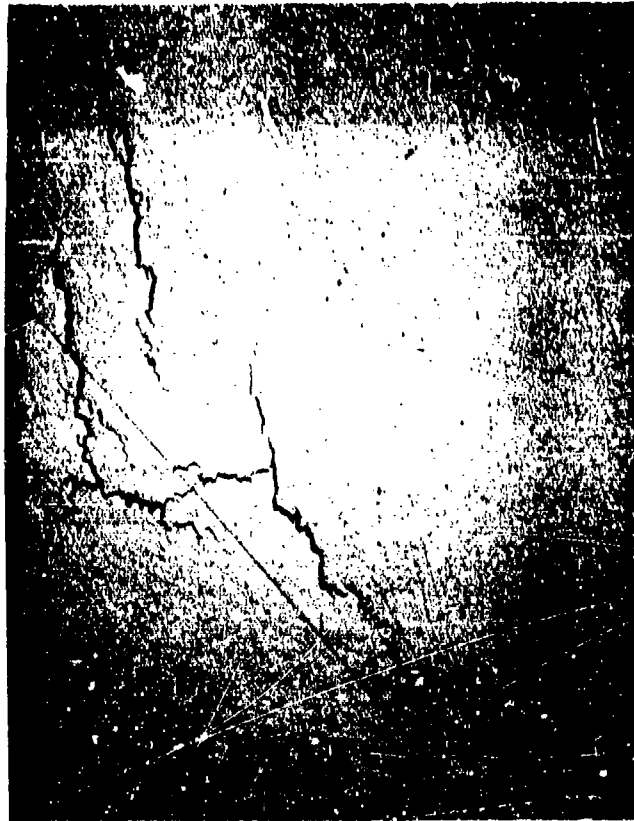

Figure B-6. Cross Section of Crack in
Figure B-4 and B-5. General
Corrosion and Pitting Observable at
Exterior Surface (Left)

B-8



**Figure B-7. Same as Figure B-6 Except
Closer to Weld. Obvious Exfoliation
at Two Exterior Sites**



Figure B-8. Same as Figure B-7. Circled Area is Location of Crack in Figures B-4 and B-5. Arrows Point to Another Branch of the Same Crack

B-10



Figure B-9. Same as Figures B-6 and B-7,
Except Still Closer to Weld. Exfoliation at
Two Exterior Sites. Crack Penetrated
Through Thickness in Lower Left; Same
Crack as in Figures B-4 and B-5

B-11/B-12

Reproduced from
best available copy.

APPENDIX C

REPORT ON CRACK IN PIPE-TO-PLATE WELD

PROJECT 305810 RJ REPORT NO. 485

LABORATORY TEST REPORT		Report Nr. 485	Date 19 Apr 72
Requesting Organization (Symbol and/or Name) AFRPL/LKCC		Name of Requestor Lt H. White	Phone Number 32320
Sample, Test or Project 305810RJ			
Work Required Determine Cause of Crack in Pipe-to-Plate Weld			
TEST DATA			
<p>I. <u>MATERIAL</u>: 6061 Al alloy pipe; 2021 Al alloy head plate.</p> <p>II. <u>BACKGROUND</u>: Tank leaked in storage testing due to crack in weld of plumbing pipe to head plate (Figures 1-3). (Only identification on the head plate was: POS. #45)</p> <p>III. <u>CONCLUSIONS</u>: A crack, caused by stress, developed in the HAZ (heat affected zone) of the circumferential weld. In some regions the crack network passed entirely through the weldment to the seating space (or mating gap) between the head plate and the pipe (Figs 8, 9). Thus the crack completed an exit path for the effluent stored propellant.</p> <p>IV. <u>OBSERVATIONS & DISCUSSION</u>:</p> <p>Extensive metallography of the weldment was carried out in an attempt to determine the factors which promoted the initiation and progression of the stress crack. The crack initiated in a fillet (Figs 2,3,5) located in the HAZ and pursued a typical intergranular path. What metallurgically determined that, when the pipe was stressed (probably deflected), a crack would occur at this location is largely unknown to date. For metallurgical interests a few microstructural details could be noted: five different precipitates were observed near the crack at 500X; the grains near the crack etched much faster than other adjacent areas; superficial hardness tests led to the following data -- 109-118 BHN in the plate, 72-94 BHN in the HAZ around the crack, 56-57 BHN in the weld filler. If a crack were to occur, the fillet is structurally the reasonable site for initiation. The microstructure beneath the fillet seems to have peculiar characteristics, which must have contributed to the possibility of propagating the crack. However, as stated above, no strict metallurgical explanation for the crack can be given by this lab. (Note: Lack of corrosion along the crack and corrosion penetration on the surface, exclude it from being a stress corrosion crack). The attached photographs identify the crack and show its appearance at successive cross-sections. On the surface the crack covered 192° of the weld circumference. Notice in Figs 8 & 9 the path available for the tank contents to escape: up the mating gap and out through the crack.</p>			
It is certified that this is an accurate report of test or analysis performed by the Chemical & Materials Branch.			
Performed By		Signature of Approving Official	
Name <i>G. S. Whiting</i> G. S. WHITING, Sgt	Name	Name JOHN T. NAKAMURA <i>John T. Nakamura</i>	
Name	Name	Title Chief	Analytical Section
		Chemical & Materials Branch	



Figure C-1. 6061 Al Alloy Pipe Welded
to 2021 Al Alloy Head Plate (From
a Propellant Storage Tank)

C-2



Figure C-2. One-Half of Crack in HAZ
of Weldment in Figure C-1.

C-3

Reproduced from
best available copy. 



Figure C-3. Second Half of Crack (Figure C-2)
in HAZ of Weldment in Figure C-1

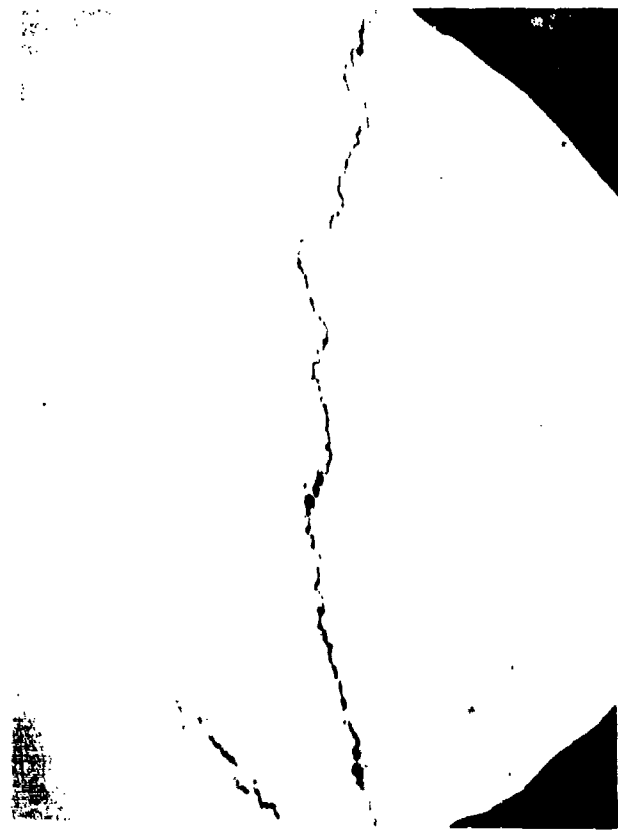

Figure C-4. First Cross-Section of Crack.
(Plane of Cross-Section is Parallel to
Long Axis of Pipe)

C-5



**Figure C-5. Second Cross-Section of Crack.
(0.03 in. Deeper Than First)**



**Figure C-6. Third Cross-Section of Crack.
(0.07 in. Deeper Than Second)**

C-7

Reproduced from
best available copy. (C)

PLATE

WELD

Figure C-7. Fourth Cross-Section of Crack.
(0.05 in. Deeper Than Third)

C-8

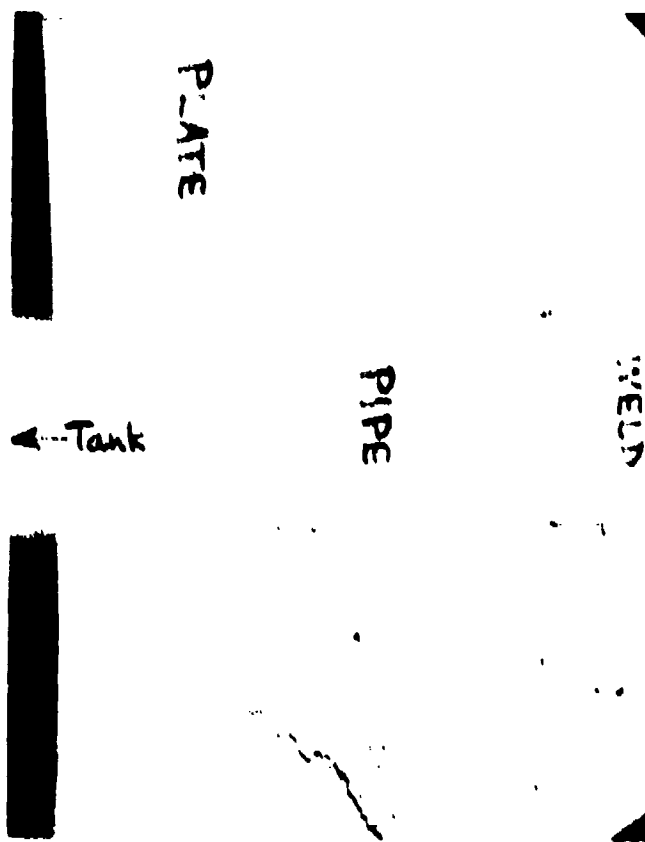

Figure C-8. Fifth Cross-Section of Crack.
Pipe in Center. Tank to Left. Weld at
Right. (0.01 Deeper Than Fourth)

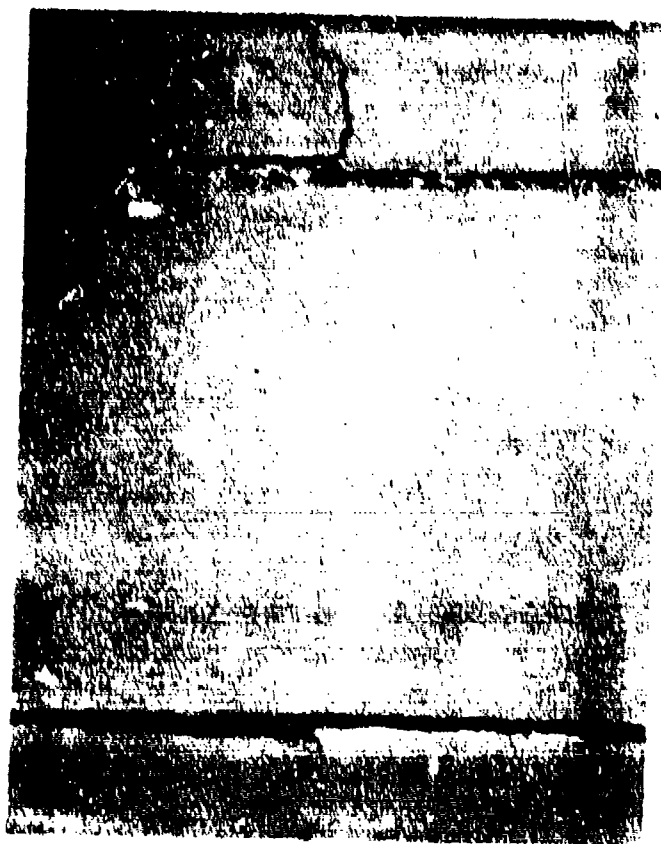

Figure C-9. Same as Figure C-8. Crack
Completed to Mating Gap of Pipe and
Plate Hole

C-10